



# WL24-2B230

W24

PHOTOELECTRIC SENSORS

**SICK**  
Sensor Intelligence.



Illustration may differ



## Ordering information

Type	part no.
WL24-2B230	1015852

Other models and accessories → [www.sick.com/W24](http://www.sick.com/W24)

## Detailed technical data

### Features

<b>Functional principle</b>	Photoelectric retro-reflective sensor
<b>Functional principle detail</b>	With minimum distance to reflector (dual lens system)
<b>Dimensions (W x H x D)</b>	27 mm x 87.5 mm x 65 mm
<b>Housing design (light emission)</b>	Rectangular
<b>Sensing range max.</b>	0 m ... 22 m <sup>1)</sup>
<b>Sensing range</b>	0 m ... 15 m <sup>1)</sup>
<b>Type of light</b>	Visible red light
<b>Light source</b>	LED <sup>2)</sup>
<b>Light spot size (distance)</b>	Ø 250 mm (15 m)
<b>Adjustment</b>	Potentiometer

<sup>1)</sup> Reflector PL80A.

<sup>2)</sup> Average service life: 100,000 h at T<sub>J</sub> = +25 °C.

### Mechanics/electronics

<b>Supply voltage U<sub>B</sub></b>	10 V DC ... 30 V DC <sup>1)</sup>
<b>Ripple</b>	< 5 V <sub>pp</sub> <sup>2)</sup>

<sup>1)</sup> Limit values when operated in short-circuit protected network: max. 8 A.

<sup>2)</sup> May not fall below or exceed U<sub>V</sub> tolerances.

<sup>3)</sup> Without load.

<sup>4)</sup> Signal transit time with resistive load.

<sup>5)</sup> With light/dark ratio 1:1.

<sup>6)</sup> A = V<sub>S</sub> connections reverse-polarity protected.

<sup>7)</sup> C = interference suppression.

<sup>8)</sup> D = outputs overcurrent and short-circuit protected.

<sup>9)</sup> Reference voltage: 50 V DC.

<b>Current consumption</b>	50 mA <sup>3)</sup>
<b>Switching output</b>	NPN, PNP
<b>Switching mode</b>	Light/dark switching
<b>Switching mode selector</b>	Selectable via PNP/NPN selector, selectable via light/dark selector
<b>Output current I<sub>max.</sub></b>	≤ 100 mA
<b>Response time</b>	≤ 500 μs <sup>4)</sup>
<b>Switching frequency</b>	1,000 Hz <sup>5)</sup>
<b>Connection type</b>	Terminal connection with M16 gland
<b>Circuit protection</b>	A <sup>6)</sup> C <sup>7)</sup> D <sup>8)</sup>
<b>Protection class</b>	II <sup>9)</sup>
<b>Weight</b>	330 g
<b>Polarisation filter</b>	✓
<b>Housing material</b>	Metal, zinc diecast
<b>Optics material</b>	Plastic, PMMA
<b>Enclosure rating</b>	IP67
<b>Test input sender off</b>	TE to 0 V
<b>Ambient operating temperature</b>	-40 °C ... +60 °C
<b>Ambient temperature, storage</b>	-40 °C ... +75 °C
<b>UL File No.</b>	NRKH.E181493 & NRKH7.E181493

<sup>1)</sup> Limit values when operated in short-circuit protected network: max. 8 A.

<sup>2)</sup> May not fall below or exceed U<sub>y</sub> tolerances.

<sup>3)</sup> Without load.

<sup>4)</sup> Signal transit time with resistive load.

<sup>5)</sup> With light/dark ratio 1:1.

<sup>6)</sup> A = V<sub>S</sub> connections reverse-polarity protected.

<sup>7)</sup> C = interference suppression.

<sup>8)</sup> D = outputs overcurrent and short-circuit protected.

<sup>9)</sup> Reference voltage: 50 V DC.

### Safety-related parameters

<b>MTTF<sub>D</sub></b>	431 years
<b>DC<sub>avg</sub></b>	0 %

### Certificates

<b>EU declaration of conformity</b>	✓
<b>UK declaration of conformity</b>	✓
<b>ACMA declaration of conformity</b>	✓
<b>Moroccan declaration of conformity</b>	✓
<b>China RoHS</b>	✓
<b>cULus certificate</b>	✓
<b>Photobiological safety (DIN EN 62471) certificate</b>	✓

### Classifications

<b>ECLASS 5.0</b>	27270902
<b>ECLASS 5.1.4</b>	27270902
<b>ECLASS 6.0</b>	27270902
<b>ECLASS 6.2</b>	27270902
<b>ECLASS 7.0</b>	27270902
<b>ECLASS 8.0</b>	27270902
<b>ECLASS 8.1</b>	27270902
<b>ECLASS 9.0</b>	27270902
<b>ECLASS 10.0</b>	27270902
<b>ECLASS 11.0</b>	27270902
<b>ECLASS 12.0</b>	27270902
<b>ETIM 5.0</b>	EC002717
<b>ETIM 6.0</b>	EC002717
<b>ETIM 7.0</b>	EC002717
<b>ETIM 8.0</b>	EC002717
<b>UNSPSC 16.0901</b>	39121528

### Adjustments WT24-2, WL24-2, WS/WE24-2, DC

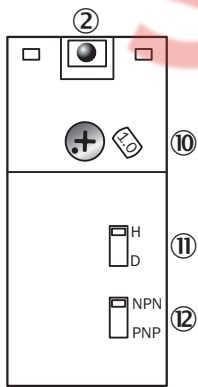

- ② LED signal strength indicator
- ⑩ Adjust sensing range (WT) / sensitivity (WL, WS/WE)
- ⑪ Light/dark selector
- ⑫ NPN/PNP changeover switch

### Connection type

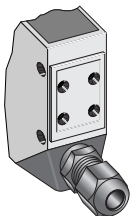

### Connection diagram Cd-120

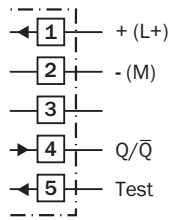

### Characteristic curve

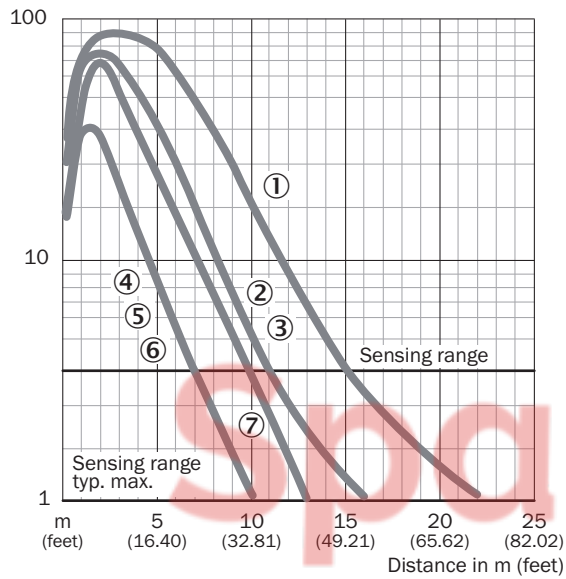

- ① Reflector PL80A
- ② Reflector PL50A
- ③ Reflector PL40A
- ④ Reflector PL30A
- ⑤ Reflector PL20A
- ⑥ Reflective tape Diamond Grade
- ⑦ Reflector C110A

Sensing range diagram

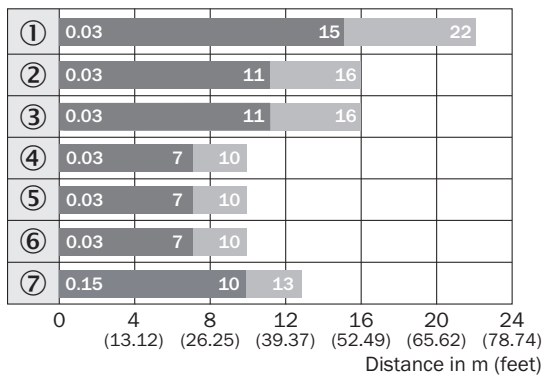

■ Sensing range      ■ Sensing range max.

- ① Reflector PL80A
- ② Reflector PL50A
- ③ Reflector PL40A
- ④ Reflector PL30A
- ⑤ Reflector PL20A
- ⑥ Reflective tape Diamond Grade
- ⑦ Reflector C110A

Dimensional drawing WL24-2

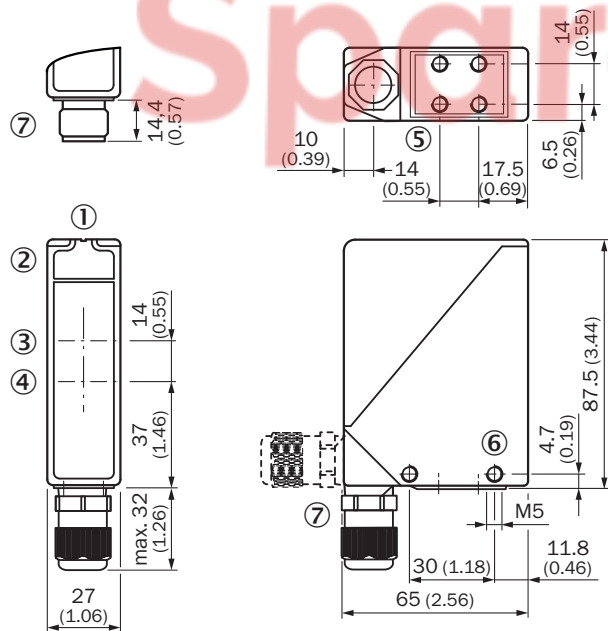





Dimensions in mm (inch)

- ① Alignment sight
- ② LED signal strength indicator
- ③ Center of optical axis, sender
- ④ Center of optical axis, receiver
- ⑤ M5 threaded mounting hole, 6 mm deep
- ⑥ M5 threaded mounting hole, through-hole
- ⑦ M16 screw fixing and plug rotatable by 90°

## Recommended accessories

Other models and accessories → [www.sick.com/W24](http://www.sick.com/W24)

	Brief description	Type	part no.
Mounting systems			
	<ul style="list-style-type: none"> <li><b>Description:</b> Mounting bracket, large</li> <li><b>Material:</b> Stainless steel</li> <li><b>Details:</b> Stainless steel</li> <li><b>Items supplied:</b> Without mounting hardware for the sensor</li> <li><b>Suitable for:</b> W24-2</li> </ul>	BEF-WG-W24	4026324
	<ul style="list-style-type: none"> <li><b>Description:</b> Mounting bracket</li> <li><b>Material:</b> Stainless steel</li> <li><b>Details:</b> Stainless steel (1.4301)</li> <li><b>Items supplied:</b> Mounting hardware included</li> <li><b>Suitable for:</b> W24-2, W34</li> </ul>	BEF-WN-W24	2015248
	<ul style="list-style-type: none"> <li><b>Description:</b> Universal mounting bracket for reflectors</li> <li><b>Dimensions (W x H x L):</b> 85 mm x 90 mm x 35 mm</li> <li><b>Material:</b> Steel</li> <li><b>Details:</b> Steel, zinc coated</li> <li><b>Suitable for:</b> C110A, P250, PL20, PL30A, PL40A, PL80A</li> </ul>	BEF-WN-REFX	2064574
reflectors and optics			
	<ul style="list-style-type: none"> <li><b>Description:</b> Rectangular, screw connection</li> <li><b>Dimensions:</b> 84 mm 84 mm</li> <li><b>Ambient operating temperature:</b> -30 °C ... +65 °C</li> </ul>	PL80A	1003865

## SICK AT A GLANCE

SICK is one of the leading manufacturers of intelligent sensors and sensor solutions for industrial applications. A unique range of products and services creates the perfect basis for controlling processes securely and efficiently, protecting individuals from accidents and preventing damage to the environment.

We have extensive experience in a wide range of industries and understand their processes and requirements. With intelligent sensors, we can deliver exactly what our customers need. In application centers in Europe, Asia and North America, system solutions are tested and optimized in accordance with customer specifications. All this makes us a reliable supplier and development partner.

Comprehensive services complete our offering: SICK LifeTime Services provide support throughout the machine life cycle and ensure safety and productivity.

For us, that is “Sensor Intelligence.”

### WORLDWIDE PRESENCE:

Contacts and other locations – [www.sick.com](http://www.sick.com)

SpareCruX