



WL24-2R240

W24

PHOTOELECTRIC SENSORS

SICK
Sensor Intelligence.



Ordering information

Type	part no.
WL24-2R240	1017858

Other models and accessories → www.sick.com/W24

Illustration may differ

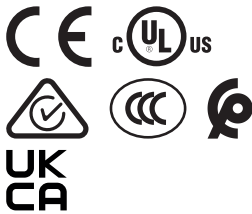

Detailed technical data

Features

Functional principle	Photoelectric retro-reflective sensor
Functional principle detail	With minimum distance to reflector (dual lens system)
Dimensions (W x H x D)	27 mm x 87.5 mm x 65 mm
Housing design (light emission)	Rectangular
Sensing range max.	0 m ... 22 m ¹⁾
Sensing range	0 m ... 15 m ¹⁾
Type of light	Visible red light
Light source	LED ²⁾
Light spot size (distance)	Ø 250 mm (15 m)
Adjustment	Potentiometer

¹⁾ Reflector PL80A.

²⁾ Average service life: 100,000 h at T_J = +25 °C.

Mechanics/electronics

Supply voltage U_B	20 V AC/DC ... 250 V AC/DC
Power consumption	< 3 VA
Switching output	Relay, electrically isolated ¹⁾

¹⁾ Provide suitable spark suppression for inductive or capacitive loads.

²⁾ With light/dark ratio 1:1.

³⁾ A = V_S connections reverse-polarity protected.

⁴⁾ C = interference suppression.

⁵⁾ Rated voltage: 250 V AC/DC.

⁶⁾ Static, low heat output, use in +5 °C ... +15 °C.

Output function	Change-over contacts
Switching mode	Light/dark switching ¹⁾
Switching mode selector	Selectable via light/dark selector
Switching current (switching voltage)	4 A @ 250 V AC, 4 A @ 24 V DC, 0.125 A @ 250 V DC UL: 4 A @ 250 V AC, general use / 4 A @ 250 V AC, resistive (NO) / 3 A @ 250 V AC, resistive (NC) / 4 A @ 24 V DC, NO, general use / 3 A @ 24 V DC, NC, general use / R300 / B300 (NO contacts only)
Response time	≤ 10 ms
Switching frequency	10 Hz ²⁾
Time functions	Switch-on delay Off delay
Delay time	Adjustable via time delay selector switch, 0.5 s ... 10 s
Connection type	Terminal connection with M16 gland
Circuit protection	A ³⁾ C ⁴⁾
Protection class	II ⁵⁾
Weight	330 g
Polarisation filter	✓
Front screen heating	✓ ⁶⁾
Housing material	Metal, zinc diecast
Optics material	Plastic, PMMA
Enclosure rating	IP67
Usage category	AC-15, DC-13 According to EN 60947-1
Ambient operating temperature	-40 °C ... +60 °C
Ambient temperature, storage	-40 °C ... +75 °C
UL File No.	NRKH.E181493 & NRKH7.E181493

¹⁾ Provide suitable spark suppression for inductive or capacitive loads.

²⁾ With light/dark ratio 1:1.

³⁾ A = V_S connections reverse-polarity protected.

⁴⁾ C = interference suppression.

⁵⁾ Rated voltage: 250 V AC/DC.

⁶⁾ Static, low heat output, use in +5 °C ... +15 °C.

Safety-related parameters

MTTF_D	478 years
DC_{avg}	0 %
T_M (mission time)	20 years

Certificates

EU declaration of conformity	✓
UK declaration of conformity	✓
ACMA declaration of conformity	✓
Moroccan declaration of conformity	✓
China RoHS	✓
CCC certificate	✓

cULus certificate	✓
Photobiological safety (DIN EN 62471) certificate	✓

Classifications

ECLASS 5.0	27270902
ECLASS 5.1.4	27270902
ECLASS 6.0	27270902
ECLASS 6.2	27270902
ECLASS 7.0	27270902
ECLASS 8.0	27270902
ECLASS 8.1	27270902
ECLASS 9.0	27270902
ECLASS 10.0	27270902
ECLASS 11.0	27270902
ECLASS 12.0	27270902
ETIM 5.0	EC002717
ETIM 6.0	EC002717
ETIM 7.0	EC002717
ETIM 8.0	EC002717
UNSPSC 16.0901	39121528

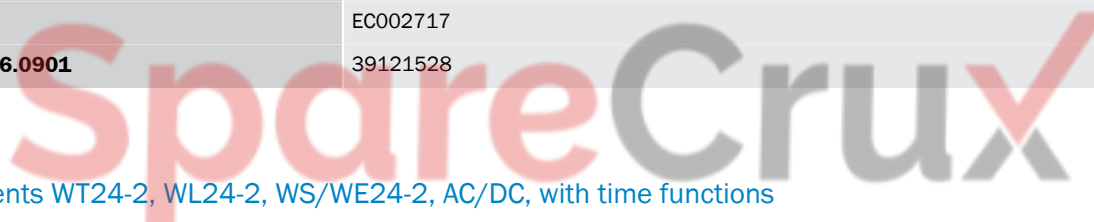

Adjustments WT24-2, WL24-2, WS/WE24-2, AC/DC, with time functions

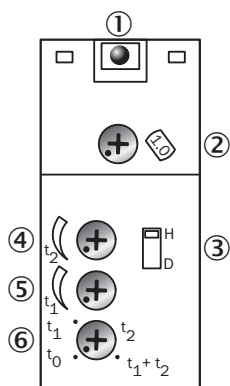

- ① Receive indicator
- ② Adjustment sensing range (WT) / sensitivity (WL, WS/WE)
- ③ Light/dark selector
- ④ time control t_2 = OFF delay
- ⑤ time control t_1 = ON delay
- ⑥ time delay selector switch

Connection type

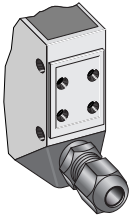

Connection diagram Cd-167

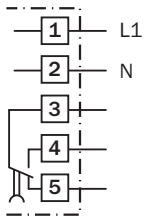

Characteristic curve

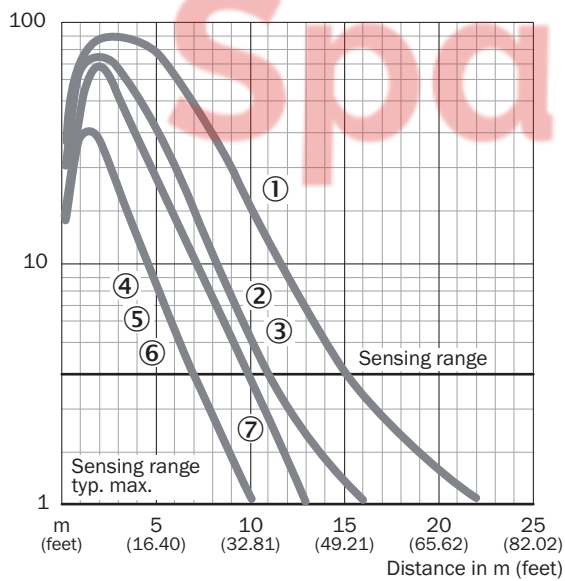

- ① Reflector PL80A
- ② Reflector PL50A
- ③ Reflector PL40A
- ④ Reflector PL30A
- ⑤ Reflector PL20A
- ⑥ Reflective tape Diamond Grade
- ⑦ Reflector C110A

Sensing range diagram

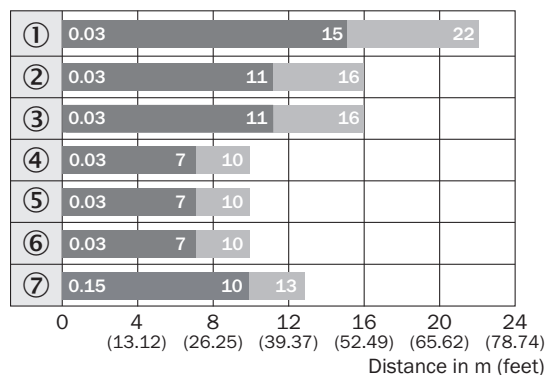

■ Sensing range ■ Sensing range max.

- ① Reflector PL80A
- ② Reflector PL50A
- ③ Reflector PL40A
- ④ Reflector PL30A
- ⑤ Reflector PL20A
- ⑥ Reflective tape Diamond Grade
- ⑦ Reflector C110A

Dimensional drawing WL24-2

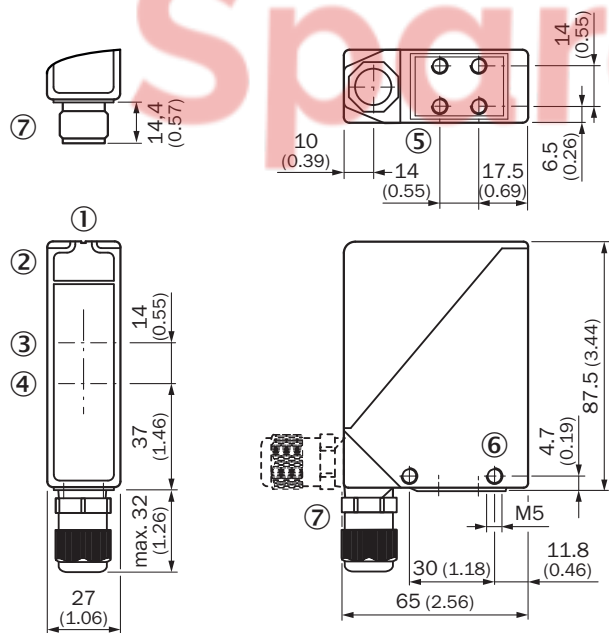





Dimensions in mm (inch)

- ① Alignment sight
- ② LED signal strength indicator
- ③ Center of optical axis, sender
- ④ Center of optical axis, receiver
- ⑤ M5 threaded mounting hole, 6 mm deep
- ⑥ M5 threaded mounting hole, through-hole
- ⑦ M16 screw fixing and plug rotatable by 90°

Recommended accessories

Other models and accessories → www.sick.com/W24

	Brief description	Type	part no.
Mounting systems			
	<ul style="list-style-type: none"> Description: Mounting bracket, large Material: Stainless steel Details: Stainless steel Items supplied: Without mounting hardware for the sensor Suitable for: W24-2 	BEF-WG-W24	4026324
	<ul style="list-style-type: none"> Description: Mounting bracket Material: Stainless steel Details: Stainless steel (1.4301) Items supplied: Mounting hardware included Suitable for: W24-2, W34 	BEF-WN-W24	2015248
	<ul style="list-style-type: none"> Description: Universal mounting bracket for reflectors Dimensions (W x H x L): 85 mm x 90 mm x 35 mm Material: Steel Details: Steel, zinc coated Suitable for: C110A, P250, PL20, PL30A, PL40A, PL80A 	BEF-WN-REFX	2064574
reflectors and optics			
	<ul style="list-style-type: none"> Description: Rectangular, screw connection Dimensions: 84 mm 84 mm Ambient operating temperature: -30 °C ... +65 °C 	PL80A	1003865

SICK AT A GLANCE

SICK is one of the leading manufacturers of intelligent sensors and sensor solutions for industrial applications. A unique range of products and services creates the perfect basis for controlling processes securely and efficiently, protecting individuals from accidents and preventing damage to the environment.

We have extensive experience in a wide range of industries and understand their processes and requirements. With intelligent sensors, we can deliver exactly what our customers need. In application centers in Europe, Asia and North America, system solutions are tested and optimized in accordance with customer specifications. All this makes us a reliable supplier and development partner.

Comprehensive services complete our offering: SICK LifeTime Services provide support throughout the machine life cycle and ensure safety and productivity.

For us, that is “Sensor Intelligence.”

WORLDWIDE PRESENCE:

Contacts and other locations – www.sick.com

SpareCruX