



WL24-2B333

W24

PHOTOELECTRIC SENSORS

SICK
Sensor Intelligence.



Illustration may differ



Ordering information

Type	part no.
WL24-2B333	1017878

Other models and accessories → www.sick.com/W24

Detailed technical data

Features

Functional principle	Photoelectric retro-reflective sensor
Functional principle detail	With minimum distance to reflector (dual lens system)
Dimensions (W x H x D)	27 mm x 87.5 mm x 65 mm
Housing design (light emission)	Rectangular
Sensing range max.	0 m ... 22 m ¹⁾
Sensing range	0 m ... 15 m ¹⁾
Type of light	Visible red light
Light source	LED ²⁾
Light spot size (distance)	Ø 250 mm (15 m)
Adjustment	Potentiometer

¹⁾ Reflector PL80A.

²⁾ Average service life: 100,000 h at T_J = +25 °C.

Mechanics/electronics

Supply voltage U_B	10 V DC ... 30 V DC ¹⁾
Ripple	< 5 V _{pp} ²⁾

¹⁾ Limit values when operated in short-circuit protected network: max. 8 A.

²⁾ May not fall below or exceed U_V tolerances.

³⁾ Without load.

⁴⁾ Signal transit time with resistive load.

⁵⁾ With light/dark ratio 1:1.

⁶⁾ A = V_S connections reverse-polarity protected.

⁷⁾ C = interference suppression.

⁸⁾ D = outputs overcurrent and short-circuit protected.

⁹⁾ Reference voltage: 50 V DC.

Current consumption	50 mA ³⁾
Switching output	NPN, PNP
Switching mode	Light/dark switching
Switching mode selector	Selectable via PNP/NPN selector, selectable via light/dark selector
Output current I_{max.}	≤ 100 mA
Response time	≤ 500 μs ⁴⁾
Switching frequency	1,000 Hz ⁵⁾
Connection type	Cubic connector, 3-pin
Circuit protection	A ⁶⁾ C ⁷⁾ D ⁸⁾
Protection class	II ⁹⁾
Weight	330 g
Polarisation filter	✓
Housing material	Metal, zinc diecast
Optics material	Plastic, PMMA
Enclosure rating	IP67
Ambient operating temperature	-40 °C ... +60 °C
Ambient temperature, storage	-40 °C ... +75 °C
UL File No.	NRKH.E181493 & NRKH7.E181493

1) Limit values when operated in short-circuit protected network: max. 8 A.

2) May not fall below or exceed U_y tolerances.

3) Without load.

4) Signal transit time with resistive load.

5) With light/dark ratio 1:1.

6) A = V_S connections reverse-polarity protected.

7) C = interference suppression.

8) D = outputs overcurrent and short-circuit protected.

9) Reference voltage: 50 V DC.

Safety-related parameters

MTTF_D	748 years
DC_{avg}	0 %
T_M (mission time)	20 years

Certificates

EU declaration of conformity	✓
UK declaration of conformity	✓
ACMA declaration of conformity	✓
Moroccan declaration of conformity	✓
China RoHS	✓
cULus certificate	✓
Photobiological safety (DIN EN 62471) certificate	✓

Classifications

ECLASS 5.0	27270902
ECLASS 5.1.4	27270902
ECLASS 6.0	27270902
ECLASS 6.2	27270902
ECLASS 7.0	27270902
ECLASS 8.0	27270902
ECLASS 8.1	27270902
ECLASS 9.0	27270902
ECLASS 10.0	27270902
ECLASS 11.0	27270902
ECLASS 12.0	27270902
ETIM 5.0	EC002717
ETIM 6.0	EC002717
ETIM 7.0	EC002717
ETIM 8.0	EC002717
UNSPSC 16.0901	39121528

Adjustments WT24-2, WL24-2, WS/WE24-2, DC

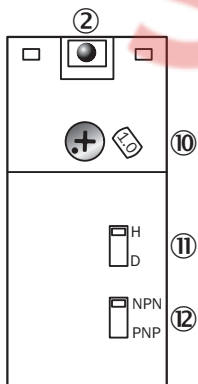

- ② LED signal strength indicator
- ⑩ Adjustment sensing range (WT) / sensitivity (WL, WS/WE)
- ⑪ Light/dark selector
- ⑫ NPN/PNP changeover switch

Connection type

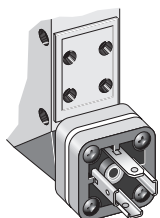

Connection diagram Cd-056

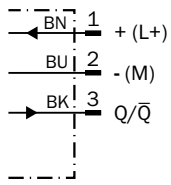

Characteristic curve

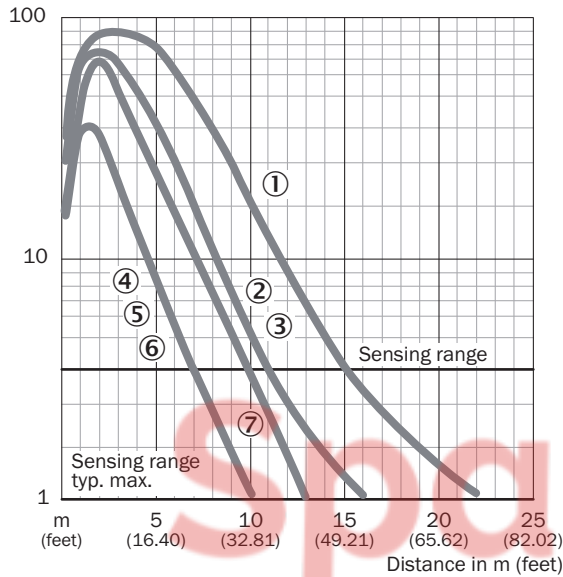

- ① Reflector PL80A
- ② Reflector PL50A
- ③ Reflector PL40A
- ④ Reflector PL30A
- ⑤ Reflector PL20A
- ⑥ Reflective tape Diamond Grade
- ⑦ Reflector C110A

Sensing range diagram

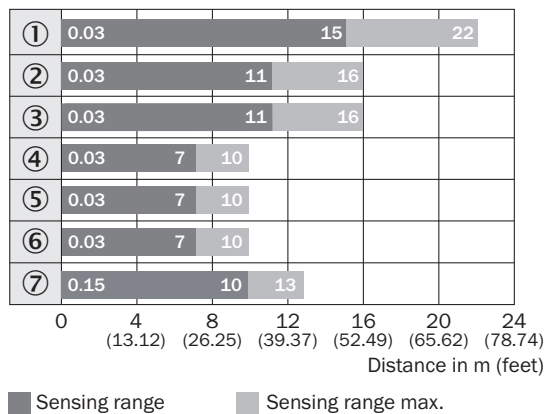

- ① Reflector PL80A
- ② Reflector PL50A
- ③ Reflector PL40A
- ④ Reflector PL30A
- ⑤ Reflector PL20A
- ⑥ Reflective tape Diamond Grade
- ⑦ Reflector C110A

Dimensional drawing WL24-2

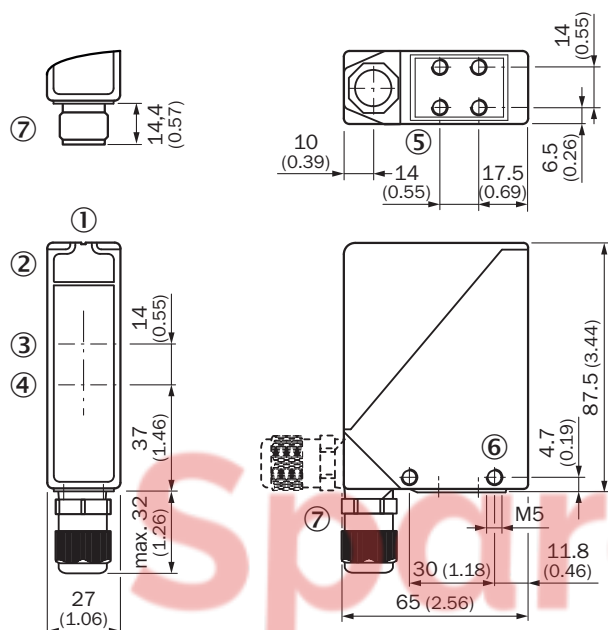



Dimensions in mm (inch)

- ① Alignment sight
- ② LED signal strength indicator
- ③ Center of optical axis, sender
- ④ Center of optical axis, receiver
- ⑤ M5 threaded mounting hole, 6 mm deep
- ⑥ M5 threaded mounting hole, through-hole
- ⑦ M16 screw fixing and plug rotatable by 90°

Recommended accessories

Other models and accessories → www.sick.com/W24

	Brief description	Type	part no.
connectors and cables			
	<ul style="list-style-type: none"> • Connection type head A: Female connector, DIN 43650, 4-pin, angled • Description: Unshielded • Connection systems: Screw-type terminals • Permitted cross-section: 0.14 mm² ... 0.5 mm² 	DOS-0303-W	6005698

	Brief description	Type	part no.
Mounting systems			
	<ul style="list-style-type: none"> Description: Mounting bracket, large Material: Stainless steel Details: Stainless steel Items supplied: Without mounting hardware for the sensor Suitable for: W24-2 	BEF-WG-W24	4026324
	<ul style="list-style-type: none"> Description: Mounting bracket Material: Stainless steel Details: Stainless steel (1.4301) Items supplied: Mounting hardware included Suitable for: W24-2, W34 	BEF-WN-W24	2015248
	<ul style="list-style-type: none"> Description: Universal mounting bracket for reflectors Dimensions (W x H x L): 85 mm x 90 mm x 35 mm Material: Steel Details: Steel, zinc coated Suitable for: C110A, P250, PL20, PL30A, PL40A, PL80A 	BEF-WN-REFX	2064574
reflectors and optics			
	<ul style="list-style-type: none"> Description: Rectangular, screw connection Dimensions: 84 mm 84 mm Ambient operating temperature: -30 °C ... +65 °C 	PL80A	1003865

SpareCruX

SICK AT A GLANCE

SICK is one of the leading manufacturers of intelligent sensors and sensor solutions for industrial applications. A unique range of products and services creates the perfect basis for controlling processes securely and efficiently, protecting individuals from accidents and preventing damage to the environment.

We have extensive experience in a wide range of industries and understand their processes and requirements. With intelligent sensors, we can deliver exactly what our customers need. In application centers in Europe, Asia and North America, system solutions are tested and optimized in accordance with customer specifications. All this makes us a reliable supplier and development partner.

Comprehensive services complete our offering: SICK LifeTime Services provide support throughout the machine life cycle and ensure safety and productivity.

For us, that is “Sensor Intelligence.”

WORLDWIDE PRESENCE:

Contacts and other locations – www.sick.com

SpareCruX