



IMB08-04NPOVT0K

IMB

INDUCTIVE PROXIMITY SENSORS

SICK
Sensor Intelligence.



Ordering information

Type	part no.
IMB08-04NPOVTOK	1072695

Included in delivery: BEF-MU-M08N (1)

Other models and accessories → www.sick.com/IMB

Illustration may differ



Detailed technical data

Features

Housing	Metric
Housing	Short-body
Thread size	M8 x 1
Diameter	Ø 8 mm
Sensing range S_n	4 mm
Safe sensing range S_a	3.24 mm
Installation type	Non-flush
Switching frequency	4,000 Hz
Connection type	Connector M8, 3-pin ¹⁾
Switching output	PNP
Switching output detail	PNP
Output function	NC
Electrical wiring	DC 3-wire
Enclosure rating	IP68 ²⁾ IP69K ³⁾
Special features	Resistant against coolant lubricants, Visual adjustment indicator, Temperature resistance
Special applications	Zones with coolants and lubricants, Mobile machines, Difficult application conditions
Items supplied	Mounting nut, V2A stainless steel, with locking teeth (2x)

¹⁾ With gold plated contact pins.

²⁾ According to EN 60529.

³⁾ According to ISO 20653:2013-03.

Mechanics/electronics

Supply voltage	10 V DC ... 30 V DC
Ripple	≤ 10 %
Voltage drop	≤ 2 V ¹⁾
Hysteresis	3 % ... 20 %
Reproducibility	≤ 2 % ²⁾ ³⁾
Temperature drift (of S_r)	± 10 %
EMC	According to EN 60947-5-2
Continuous current I_a	≤ 200 mA
No load current	≤ 10 mA
Short-circuit protection	✓
Power-up pulse protection	✓
Shock and vibration resistance	100 g / 11 ms / 1000 cycles; 150 g / 1 Mio cycles; 10 Hz ... 55 Hz, 1 mm / 55 Hz ... 500 Hz / 15 g
Ambient operating temperature	-40 °C ... +100 °C
Housing material	Stainless steel V2A, DIN 1.4305 / AISI 303
Sensing face material	Plastic, LCP
Housing length	40 mm
Thread length	24 mm
Tightening torque, max.	Typ. 7 Nm ⁴⁾ Typ. 14 Nm ⁵⁾
Protection class	III
UL File No.	E181493

¹⁾ At I_a max.

²⁾ Supply voltage U_B and constant ambient temperature T_a.

³⁾ Of S_r.

⁴⁾ When using the non-toothed side of the nut.

⁵⁾ Valid if toothed side of nut is used.

Safety-related parameters

MTTF_D	1,971 years
DC_{avg}	0 %

Reduction factors

Note	The values are reference values which may vary
St37 steel (Fe)	1
Stainless steel (V2A, 304)	Approx. 0.69
Aluminum (Al)	Approx. 0.37
Copper (Cu)	Approx. 0.28
Brass (Br)	Approx. 0.4

Installation note

Remark	Associated graphic see "Installation"
A	8 mm

B	18 mm
C	8 mm
D	12 mm
E	8 mm
F	32 mm

Certificates

EU declaration of conformity	✓
UK declaration of conformity	✓
ACMA declaration of conformity	✓
Moroccan declaration of conformity	✓
China RoHS	✓
cULus certificate	✓

Classifications

ECLASS 5.0	27270101
ECLASS 5.1.4	27270101
ECLASS 6.0	27270101
ECLASS 6.2	27270101
ECLASS 7.0	27270101
ECLASS 8.0	27270101
ECLASS 8.1	27270101
ECLASS 9.0	27270101
ECLASS 10.0	27270101
ECLASS 11.0	27270101
ECLASS 12.0	27274001
ETIM 5.0	EC002714
ETIM 6.0	EC002714
ETIM 7.0	EC002714
ETIM 8.0	EC002714
UNSPSC 16.0901	39122230

Installation note Non-flush installation



Connection diagram Cd-004

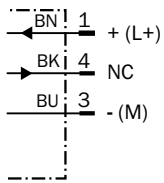

Response diagram

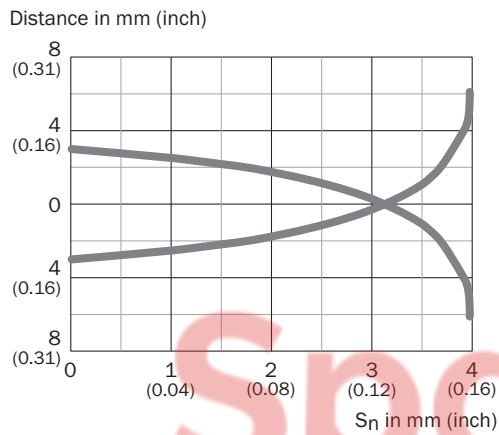

Functional principle Installation aid

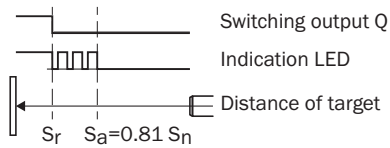

Dimensional drawing IMB08 Short-body housing, connector M8, non-flush

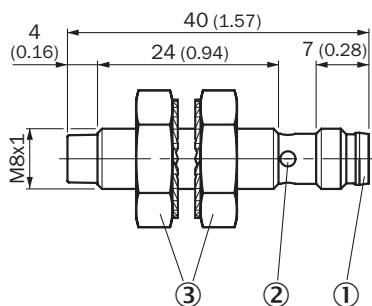



Dimensions in mm (inch)

① Connection

- ② Display LED
- ③ Fastening nuts (2 x); width across 13, stainless steel V2A

Recommended accessories

Other models and accessories → www.sick.com/IMB

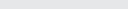

	Brief description	Type	part no.
Mounting systems			
	<ul style="list-style-type: none"> • Description: Mounting plate for M8 sensors • Material: Steel • Details: Steel, zinc coated • Items supplied: Without mounting hardware 	BEF-WG-M08	5321722
	<ul style="list-style-type: none"> • Description: Mounting bracket for M8 sensors • Material: Steel • Details: Steel, zinc coated • Items supplied: Without mounting hardware 	BEF-WN-M08	5321721

SpareCruX

	Brief description	Type	part no.
connectors and cables			
	<ul style="list-style-type: none"> • Connection type head A: Female connector, M8, 3-pin, straight • Connection type head B: Flying leads • Signal type: Sensor/actuator cable • Cable: 2 m, 4-wire, PP • Description: Sensor/actuator cable, unshielded • Connection systems: Flying leads • Note: This product is generally resistant to chemical cleaning agents (see ECOLAB) and other chemical compounds such as H2O2 and CH2O2. Before permanent installation is carried out, the material's resistance to the cleaning agent being used must be checked., Resistant against lactic acid & hydrogen peroxide (H2O2) • Application: Hygienic and washdown zones, Drag chain operation 	DOL-0803-G02MRN	6058504
	<ul style="list-style-type: none"> • Connection type head A: Female connector, M8, 3-pin, straight • Connection type head B: Flying leads • Signal type: Sensor/actuator cable • Cable: 5 m, 4-wire, PP • Description: Sensor/actuator cable, unshielded • Connection systems: Flying leads • Note: This product is generally resistant to chemical cleaning agents (see ECOLAB) and other chemical compounds such as H2O2 and CH2O2. Before permanent installation is carried out, the material's resistance to the cleaning agent being used must be checked., Resistant against lactic acid & hydrogen peroxide (H2O2) • Application: Hygienic and washdown zones, Drag chain operation 	DOL-0803-G05MRN	6058505
	<ul style="list-style-type: none"> • Connection type head A: Female connector, M8, 3-pin, angled • Connection type head B: Flying leads • Signal type: Sensor/actuator cable • Cable: 2 m, 4-wire, PP • Description: Sensor/actuator cable, unshielded • Connection systems: Flying leads • Note: This product is generally resistant to chemical cleaning agents (see ECOLAB) and other chemical compounds such as H2O2 and CH2O2. Before permanent installation is carried out, the material's resistance to the cleaning agent being used must be checked., Resistant against lactic acid & hydrogen peroxide (H2O2) • Application: Hygienic and washdown zones, Drag chain operation 	DOL-0803-W02MRN	6058507
	<ul style="list-style-type: none"> • Connection type head A: Female connector, M8, 3-pin, angled • Connection type head B: Flying leads • Signal type: Sensor/actuator cable • Cable: 5 m, 4-wire, PP • Description: Sensor/actuator cable, unshielded • Connection systems: Flying leads • Note: This product is generally resistant to chemical cleaning agents (see ECOLAB) and other chemical compounds such as H2O2 and CH2O2. Before permanent installation is carried out, the material's resistance to the cleaning agent being used must be checked. • Application: Hygienic and washdown zones, Drag chain operation 	DOL-0803-W05MRN	6058508
	<ul style="list-style-type: none"> • Connection type head A: Female connector, M8, 3-pin, angled • Connection type head B: Flying leads • Signal type: Sensor/actuator cable • Cable: 5 m, 4-wire, PP • Description: Sensor/actuator cable, unshielded • Note: This product is generally resistant to chemical cleaning agents (see ECOLAB) and other chemical compounds such as H2O2 and CH2O2. Before permanent installation is carried out, the material's resistance to the cleaning agent being used must be checked. • Application: Hygienic and washdown zones, Drag chain operation 	DOL-0803-L05MRN	6058788
	<ul style="list-style-type: none"> • Connection type head A: Female connector, M8, 3-pin, angled • Connection type head B: Flying leads • Signal type: Sensor/actuator cable • Cable: 2 m, 4-wire, PP • Description: Sensor/actuator cable, unshielded • Note: This product is generally resistant to chemical cleaning agents (see ECOLAB) and other chemical compounds such as H2O2 and CH2O2. Before permanent installation is carried out, the material's resistance to the cleaning agent being used must be checked., Resistant against lactic acid & hydrogen peroxide (H2O2), only suitable for PNP sensors • Application: Hygienic and washdown zones, Drag chain operation 	DOL-0803-L02MRN	6058787
	<ul style="list-style-type: none"> • Connection type head A: Female connector, M8, 3-pin, straight, A-coded • Connection type head B: Male connector, M8, 3-pin, straight, A-coded • Signal type: Sensor/actuator cable • Cable: 2 m, 3-wire, PUR, halogen-free • Description: Sensor/actuator cable, unshielded 	YF8U13-020UA1M8U13	2096304

	Brief description	Type	part no.
	<ul style="list-style-type: none"> Application: Uncontaminated zones, Zones with oils and lubricants, Robot, Drag chain operation Connection type head A: Female connector, M8, 3-pin, straight, A-coded Connection type head B: Male connector, M8, 3-pin, straight, A-coded Signal type: Sensor/actuator cable Cable: 5 m, 3-wire, PUR, halogen-free Description: Sensor/actuator cable, unshielded Application: Uncontaminated zones, Zones with oils and lubricants, Robot, Drag chain operation 	YF8U13-050UA1M8U13	2096308
	<ul style="list-style-type: none"> Connection type head A: Female connector, M8, 3-pin, straight, A-coded Connection type head B: Male connector, M8, 3-pin, straight, A-coded Signal type: Sensor/actuator cable Cable: 10 m, 3-wire, PUR, halogen-free Description: Sensor/actuator cable, unshielded Application: Uncontaminated zones, Zones with oils and lubricants, Robot, Drag chain operation 	YF8U13-100UA1M8U13	2096309
	<ul style="list-style-type: none"> Connection type head A: Female connector, M8, 3-pin, straight, A-coded Connection type head B: Male connector, M8, 3-pin, straight, A-coded Signal type: Sensor/actuator cable Cable: 20 m, 3-wire, PUR, halogen-free Description: Sensor/actuator cable, unshielded Application: Uncontaminated zones, Zones with oils and lubricants, Robot, Drag chain operation 	YF8U13-200UA1M8U13	2096310
	<ul style="list-style-type: none"> Connection type head A: Female connector, M8, 3-pin, straight, A-coded Connection type head B: Flying leads Signal type: Sensor/actuator cable Cable: 2 m, 3-wire, PUR, halogen-free Description: Sensor/actuator cable, unshielded Application: Uncontaminated zones, Zones with oils and lubricants, Robot, Drag chain operation 	YF8U13-020UA1XLEAX	2094782
	<ul style="list-style-type: none"> Connection type head A: Female connector, M8, 3-pin, straight, A-coded Connection type head B: Flying leads Signal type: Sensor/actuator cable Cable: 5 m, 3-wire, PUR, halogen-free Description: Sensor/actuator cable, unshielded Application: Uncontaminated zones, Zones with oils and lubricants, Robot, Drag chain operation 	YF8U13-050UA1XLEAX	2094788
	<ul style="list-style-type: none"> Connection type head A: Female connector, M8, 3-pin, straight, A-coded Connection type head B: Flying leads Signal type: Sensor/actuator cable Cable: 10 m, 3-wire, PUR, halogen-free Description: Sensor/actuator cable, unshielded Application: Uncontaminated zones, Zones with oils and lubricants, Robot, Drag chain operation 	YF8U13-100UA1XLEAX	2094789
	<ul style="list-style-type: none"> Connection type head A: Female connector, M8, 3-pin, straight, A-coded Connection type head B: Flying leads Signal type: Sensor/actuator cable Cable: 20 m, 3-wire, PUR, halogen-free Description: Sensor/actuator cable, unshielded Application: Uncontaminated zones, Zones with oils and lubricants, Robot, Drag chain operation 	YF8U13-200UA1XLEAX	2094790
	<ul style="list-style-type: none"> Connection type head A: Female connector, M8, 3-pin, angled, A-coded Connection type head B: Flying leads Signal type: Sensor/actuator cable Cable: 2 m, 3-wire, PUR, halogen-free Description: Sensor/actuator cable, unshielded Application: Uncontaminated zones, Zones with oils and lubricants, Robot, Drag chain operation 	YG8U13-020UA1XLEAX	2094794
	<ul style="list-style-type: none"> Connection type head A: Female connector, M8, 3-pin, straight, A-coded Connection type head B: Flying leads Signal type: Sensor/actuator cable Cable: 3 m, 3-wire, PUR, halogen-free Description: Sensor/actuator cable, unshielded Application: Uncontaminated zones, Zones with oils and lubricants, Robot, Drag chain operation 	YF8U13-030UA1XLEAX	2094787
	<ul style="list-style-type: none"> Connection type head A: Female connector, M8, 3-pin, angled, A-coded Connection type head B: Flying leads Signal type: Sensor/actuator cable Cable: 5 m, 3-wire, PUR, halogen-free Description: Sensor/actuator cable, unshielded Application: Uncontaminated zones, Zones with oils and lubricants, Robot, Drag chain operation 	YG8U13-050UA1XLEAX	2095586
	<ul style="list-style-type: none"> Connection type head A: Female connector, M8, 3-pin, angled, A-coded Connection type head B: Flying leads Signal type: Sensor/actuator cable Cable: 10 m, 3-wire, PUR, halogen-free Description: Sensor/actuator cable, unshielded 	YG8U13-100UA1XLEAX	2095588

	Brief description	Type	part no.
	<ul style="list-style-type: none"> Application: Uncontaminated zones, Zones with oils and lubricants, Robot, Drag chain operation Connection type head A: Female connector, M8, 3-pin, straight, A-coded Connection type head B: Flying leads Signal type: Sensor/actuator cable Cable: 1 m, 3-wire, PUR, halogen-free Description: Sensor/actuator cable, unshielded Application: Uncontaminated zones, Zones with oils and lubricants, Robot, Drag chain operation 	YF8U13-010UA1XLEAX	2094779
	<ul style="list-style-type: none"> Connection type head A: Female connector, M8, 3-pin, angled, A-coded Connection type head B: Flying leads Signal type: Sensor/actuator cable Cable: 2 m, 3-wire, PUR, halogen-free Description: Sensor/actuator cable, unshielded Note: Only suitable for PNP sensors Application: Uncontaminated zones, Zones with oils and lubricants, Robot, Drag chain operation 	YI8U13-020UA1XLEAX	2095593
	<ul style="list-style-type: none"> Connection type head A: Female connector, M8, 3-pin, angled, A-coded Connection type head B: Flying leads Signal type: Sensor/actuator cable Cable: 10 m, 3-wire, PUR, halogen-free Description: Sensor/actuator cable, unshielded Note: Only suitable for PNP sensors Application: Uncontaminated zones, Zones with oils and lubricants, Robot, Drag chain operation 	YI8U13-100UA1XLEAX	2095595
	<ul style="list-style-type: none"> Connection type head A: Female connector, M8, 3-pin, straight, A-coded Connection type head B: Flying leads Signal type: Sensor/actuator cable Cable: 0.6 m, 3-wire, PUR, halogen-free Description: Sensor/actuator cable, unshielded Application: Uncontaminated zones, Zones with oils and lubricants, Robot, Drag chain operation 	YF8U13-C60UA1XLEAX	2145888
	<ul style="list-style-type: none"> Connection type head A: Female connector, M8, 3-pin, angled, A-coded Connection type head B: Flying leads Signal type: Sensor/actuator cable Cable: 0.6 m, 3-wire, PUR, halogen-free Description: Sensor/actuator cable, unshielded Application: Uncontaminated zones, Zones with oils and lubricants, Robot, Drag chain operation 	YG8U13-C60UA1XLEAX	2145889
	<ul style="list-style-type: none"> Connection type head A: Female connector, M8, 3-pin, angled, A-coded Connection type head B: Flying leads Signal type: Sensor/actuator cable Cable: 3 m, 3-wire, PUR, halogen-free Description: Sensor/actuator cable, unshielded Application: Uncontaminated zones, Zones with oils and lubricants, Robot, Drag chain operation 	YG8U13-030UA1XLEAX	2145891
	<ul style="list-style-type: none"> Connection type head A: Female connector, M8, 3-pin, angled, A-coded Connection type head B: Flying leads Signal type: Sensor/actuator cable Cable: 0.6 m, 3-wire, PUR, halogen-free Description: Sensor/actuator cable, unshielded Note: Only suitable for PNP sensors Application: Uncontaminated zones, Zones with oils and lubricants, Robot, Drag chain operation 	YI8U13-C60UA1XLEAX	2145892
	<ul style="list-style-type: none"> Connection type head A: Female connector, M8, 3-pin, angled, A-coded Connection type head B: Flying leads Signal type: Sensor/actuator cable Cable: 3 m, 3-wire, PUR, halogen-free Description: Sensor/actuator cable, unshielded Note: Only suitable for PNP sensors Application: Uncontaminated zones, Zones with oils and lubricants, Robot, Drag chain operation 	YI8U13-030UA1XLEAX	2145894
	<ul style="list-style-type: none"> Connection type head A: Female connector, M8, 3-pin, straight Connection type head B: Flying leads Signal type: Sensor/actuator cable Cable: 15 m, 4-wire, PP Description: Sensor/actuator cable, unshielded Connection systems: Flying leads Note: This product is generally resistant to chemical cleaning agents (see ECOLAB) and other chemical compounds such as H2O2 and CH2O2. Before permanent installation is carried out, the material's resistance to the cleaning agent being used must be checked., Resistant against lactic acid & hydrogen peroxide (H2O2) Application: Hygienic and washdown zones, Drag chain operation 	YF8P13-150PA1XLEAX	2146839
	<ul style="list-style-type: none"> Connection type head A: Female connector, M8, 3-pin, straight Connection type head B: Flying leads Signal type: Sensor/actuator cable Cable: 20 m, 4-wire, PP Description: Sensor/actuator cable, unshielded Connection systems: Flying leads 	YF8P13-200PA1XLEAX	2146841

	Brief description	Type	part no.
	<ul style="list-style-type: none"> • Note: This product is generally resistant to chemical cleaning agents (see ECOLAB) and other chemical compounds such as H2O2 and CH2O2. Before permanent installation is carried out, the material's resistance to the cleaning agent being used must be checked., Resistant against lactic acid & hydrogen peroxide (H2O2) • Application: Hygienic and washdown zones, Drag chain operation 		
	<ul style="list-style-type: none"> • Connection type head A: Female connector, M8, 3-pin, straight • Connection type head B: Flying leads • Signal type: Sensor/actuator cable • Cable: 30 m, 4-wire, PP • Description: Sensor/actuator cable, unshielded • Connection systems: Flying leads • Note: This product is generally resistant to chemical cleaning agents (see ECOLAB) and other chemical compounds such as H2O2 and CH2O2. Before permanent installation is carried out, the material's resistance to the cleaning agent being used must be checked., Resistant against lactic acid & hydrogen peroxide (H2O2) • Application: Hygienic and washdown zones, Drag chain operation 	YF8P13-300PA1XLEAX	2146842
	<ul style="list-style-type: none"> • Connection type head A: Female connector, M8, 3-pin, straight • Connection type head B: Flying leads • Signal type: Sensor/actuator cable • Cable: 40 m, 4-wire, PP • Description: Sensor/actuator cable, unshielded • Connection systems: Flying leads • Note: This product is generally resistant to chemical cleaning agents (see ECOLAB) and other chemical compounds such as H2O2 and CH2O2. Before permanent installation is carried out, the material's resistance to the cleaning agent being used must be checked., Resistant against lactic acid & hydrogen peroxide (H2O2) • Application: Hygienic and washdown zones, Drag chain operation 	YF8P13-400PA1XLEAX	2146843

SpareCruX

SICK AT A GLANCE

SICK is one of the leading manufacturers of intelligent sensors and sensor solutions for industrial applications. A unique range of products and services creates the perfect basis for controlling processes securely and efficiently, protecting individuals from accidents and preventing damage to the environment.

We have extensive experience in a wide range of industries and understand their processes and requirements. With intelligent sensors, we can deliver exactly what our customers need. In application centers in Europe, Asia and North America, system solutions are tested and optimized in accordance with customer specifications. All this makes us a reliable supplier and development partner.

Comprehensive services complete our offering: SICK LifeTime Services provide support throughout the machine life cycle and ensure safety and productivity.

For us, that is “Sensor Intelligence.”

WORLDWIDE PRESENCE:

Contacts and other locations – www.sick.com

SpareCruX