

# IMB30-20NPOVU2S

IMB

INDUCTIVE PROXIMITY SENSORS

**SICK**  
Sensor Intelligence.

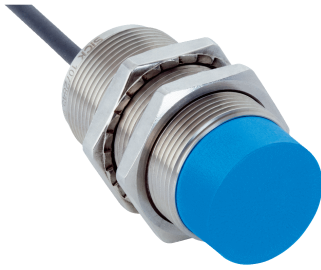

### Ordering information

Type	part no.
IMB30-20NPOVU2S	1072846

**Included in delivery:** BEF-MU-M30N (1)

Other models and accessories → [www.sick.com/IMB](http://www.sick.com/IMB)

Illustration may differ

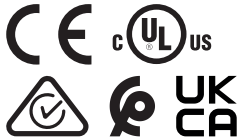

### Detailed technical data

#### Features

<b>Housing</b>	Metric
<b>Housing</b>	Standard design
<b>Thread size</b>	M30 x 1.5
<b>Diameter</b>	Ø 30 mm
<b>Sensing range <math>S_n</math></b>	20 mm
<b>Safe sensing range <math>S_a</math></b>	16.2 mm
<b>Installation type</b>	Non-flush
<b>Switching frequency</b>	500 Hz
<b>Connection type</b>	Cable, 3-wire, 2 m
<b>Switching output</b>	PNP
<b>Switching output detail</b>	PNP
<b>Output function</b>	NC
<b>Electrical wiring</b>	DC 3-wire
<b>Enclosure rating</b>	IP68 <sup>1)</sup> IP69K <sup>2)</sup>
<b>Special features</b>	Resistant against coolant lubricants, Visual adjustment indicator, Temperature resistance
<b>Special applications</b>	Zones with coolants and lubricants, Mobile machines, Difficult application conditions
<b>Items supplied</b>	Mounting nut, V2A stainless steel, with locking teeth (2x)

<sup>1)</sup> According to EN 60529.

<sup>2)</sup> According to ISO 20653:2013-03.

#### Mechanics/electronics

<b>Supply voltage</b>	10 V DC ... 30 V DC
-----------------------	---------------------

<sup>1)</sup> At  $I_a$  max.

<sup>2)</sup> Supply voltage  $U_B$  and constant ambient temperature  $T_a$ .

<sup>3)</sup> Of  $S_r$ .

<sup>4)</sup> When using the non-toothed side of the nut.

<sup>5)</sup> Valid if toothed side of nut is used.

<b>Ripple</b>	≤ 10 %
<b>Voltage drop</b>	≤ 2 V <sup>1)</sup>
<b>Hysteresis</b>	3 % ... 20 %
<b>Reproducibility</b>	≤ 2 % <sup>2)</sup> 3)
<b>Temperature drift (of S<sub>r</sub>)</b>	± 10 %
<b>EMC</b>	According to EN 60947-5-2
<b>Continuous current I<sub>a</sub></b>	≤ 200 mA
<b>No load current</b>	≤ 10 mA
<b>Cable material</b>	PUR
<b>Conductor size</b>	0.34 mm <sup>2</sup>
<b>Cable diameter</b>	Ø 4.5 mm
<b>Short-circuit protection</b>	✓
<b>Power-up pulse protection</b>	✓
<b>Shock and vibration resistance</b>	100 g / 2 ms / 500 cycles; 150 g / 1 Mio cycles; 10 Hz ... 55 Hz / 1 mm; 55 Hz ... 500 Hz / 60 g
<b>Ambient operating temperature</b>	-40 °C ... +100 °C
<b>Housing material</b>	Stainless steel V2A, DIN 1.4305 / AISI 303
<b>Sensing face material</b>	Plastic, LCP
<b>Housing length</b>	60 mm
<b>Thread length</b>	44 mm
<b>Tightening torque, max.</b>	Typ. 100 Nm <sup>4)</sup> Typ. 100 Nm <sup>5)</sup>
<b>Protection class</b>	III
<b>UL File No.</b>	E181493

1) At I<sub>a</sub> max.

2) Supply voltage U<sub>B</sub> and constant ambient temperature T<sub>a</sub>.

3) Of S<sub>r</sub>.

4) When using the non-toothed side of the nut.

5) Valid if toothed side of nut is used.

### Safety-related parameters

<b>MTTF<sub>D</sub></b>	1,971 years
<b>DC<sub>avg</sub></b>	0 %

### Reduction factors

<b>Note</b>	The values are reference values which may vary
<b>St37 steel (Fe)</b>	1
<b>Stainless steel (V2A, 304)</b>	Approx. 0.78
<b>Aluminum (Al)</b>	Approx. 0.44
<b>Copper (Cu)</b>	Approx. 0.36
<b>Brass (Br)</b>	Approx. 0.46

### Installation note

<b>Remark</b>	Associated graphic see "Installation"
---------------	---------------------------------------

<b>A</b>	20 mm
<b>B</b>	62 mm
<b>C</b>	30 mm
<b>D</b>	60 mm
<b>E</b>	20 mm
<b>F</b>	160 mm

Certificates

<b>EU declaration of conformity</b>	✓
<b>UK declaration of conformity</b>	✓
<b>ACMA declaration of conformity</b>	✓
<b>Moroccan declaration of conformity</b>	✓
<b>China RoHS</b>	✓
<b>cULus certificate</b>	✓

Classifications

<b>ECLASS 5.0</b>	27270101
<b>ECLASS 5.1.4</b>	27270101
<b>ECLASS 6.0</b>	27270101
<b>ECLASS 6.2</b>	27270101
<b>ECLASS 7.0</b>	27270101
<b>ECLASS 8.0</b>	27270101
<b>ECLASS 8.1</b>	27270101
<b>ECLASS 9.0</b>	27270101
<b>ECLASS 10.0</b>	27270101
<b>ECLASS 11.0</b>	27270101
<b>ECLASS 12.0</b>	27274001
<b>ETIM 5.0</b>	EC002714
<b>ETIM 6.0</b>	EC002714
<b>ETIM 7.0</b>	EC002714
<b>ETIM 8.0</b>	EC002714
<b>UNSPSC 16.0901</b>	39122230

Installation note Non-flush installation



Connection diagram Cd-003



Response diagram

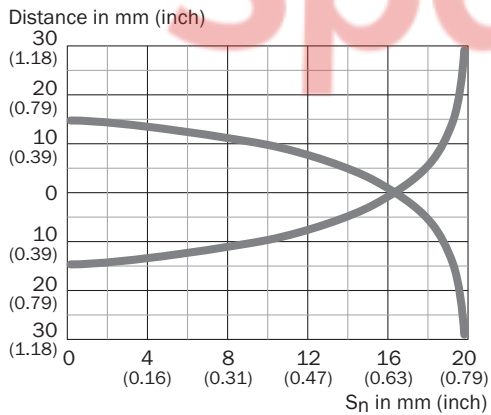

Functional principle Installation aid

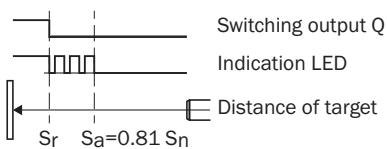

Dimensional drawing IMB30 Standard, cable, non-flush

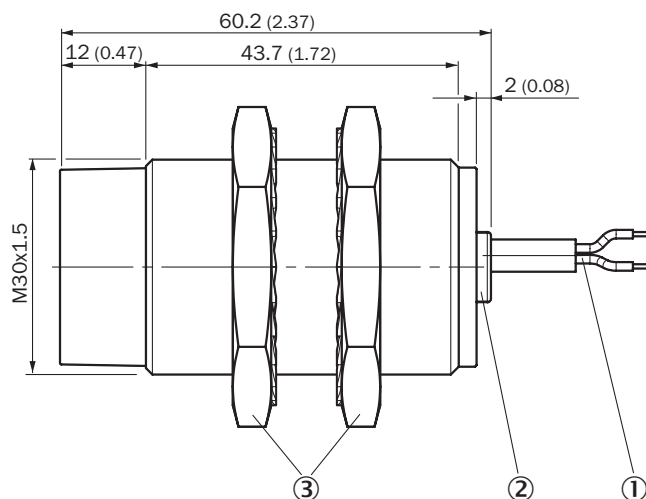





Dimensions in mm (inch)

- ① Connection
- ② Display LED
- ③ Fastening nuts (2 x); width across 36, stainless steel V2A

Recommended accessories

Other models and accessories → [www.sick.com/IMB](http://www.sick.com/IMB)

	Brief description	Type	part no.
Mounting systems			
	<ul style="list-style-type: none"> <li>• <b>Description:</b> Mounting bracket for M30 sensors</li> <li>• <b>Material:</b> Steel</li> <li>• <b>Details:</b> Steel, zinc coated</li> <li>• <b>Items supplied:</b> Without mounting hardware</li> </ul>	BEF-WN-M30	5308445
	<ul style="list-style-type: none"> <li>• <b>Description:</b> Mounting plate for M30 sensors</li> <li>• <b>Material:</b> Steel</li> <li>• <b>Details:</b> Steel, zinc coated</li> <li>• <b>Items supplied:</b> Without mounting hardware</li> </ul>	BEF-WG-M30	5321871

	Brief description	Type	part no.
connectors and cables			
	<ul style="list-style-type: none"> <li>• <b>Connection type head A:</b> Female connector, M12, 4-pin, straight, A-coded</li> <li>• <b>Description:</b> Unshielded</li> <li>• <b>Connection systems:</b> Screw-type terminals</li> <li>• <b>Permitted cross-section:</b> ≤ 0.75 mm<sup>2</sup></li> <li>• <b>Application:</b> Hygienic and washdown zones</li> </ul>	DOS-1204-GN	6028357
	<ul style="list-style-type: none"> <li>• <b>Connection type head A:</b> Female connector, M12, 4-pin, angled, A-coded</li> <li>• <b>Description:</b> Unshielded</li> <li>• <b>Connection systems:</b> Screw-type terminals</li> <li>• <b>Permitted cross-section:</b> ≤ 0.75 mm<sup>2</sup></li> <li>• <b>Application:</b> Hygienic and washdown zones</li> </ul>	DOS-1204-WN	6028358
	<ul style="list-style-type: none"> <li>• <b>Connection type head A:</b> Male connector, M12, 4-pin, straight, A-coded</li> <li>• <b>Description:</b> Unshielded</li> <li>• <b>Connection systems:</b> Screw-type terminals</li> <li>• <b>Permitted cross-section:</b> ≤ 0.75 mm<sup>2</sup></li> <li>• <b>Application:</b> Hygienic and washdown zones</li> </ul>	STE-1204-GN	6028359

SpareCruX

## SICK AT A GLANCE

SICK is one of the leading manufacturers of intelligent sensors and sensor solutions for industrial applications. A unique range of products and services creates the perfect basis for controlling processes securely and efficiently, protecting individuals from accidents and preventing damage to the environment.

We have extensive experience in a wide range of industries and understand their processes and requirements. With intelligent sensors, we can deliver exactly what our customers need. In application centers in Europe, Asia and North America, system solutions are tested and optimized in accordance with customer specifications. All this makes us a reliable supplier and development partner.

Comprehensive services complete our offering: SICK LifeTime Services provide support throughout the machine life cycle and ensure safety and productivity.

For us, that is “Sensor Intelligence.”

### WORLDWIDE PRESENCE:

Contacts and other locations – [www.sick.com](http://www.sick.com)

SpareCruX