



AFM60E-S4AA004096

AFS/AFM60 SSI

ABSOLUTE ENCODERS

SICK
Sensor Intelligence.

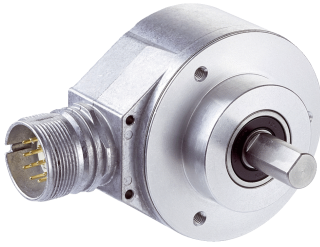

Ordering information

Type	part no.
AFM60E-S4AA004096	1037435

Other models and accessories → www.sick.com/AFS_AFM60_SSI

Illustration may differ



Detailed technical data

Safety-related parameters

MTTF_D (mean time to dangerous failure)	250 years (EN ISO 13849-1) ¹⁾
--	--

¹⁾ This product is a standard product and does not constitute a safety component as defined in the Machinery Directive. Calculation based on nominal load of components, average ambient temperature 40 °C, frequency of use 8760 h/a. All electronic failures are considered hazardous. For more information, see document no. 8015532.

Performance

Number of steps per revolution (max. resolution)	4,096 (12 bit)
Number of revolutions	4,096 (12 bit)
Max. resolution (number of steps per revolution x number of revolutions)	12 bit x 12 bit (4,096 x 4,096)
Error limits G	0.2° ¹⁾
Repeatability standard deviation σ_r	0.002° ²⁾

¹⁾ In accordance with DIN ISO 1319-1, position of the upper and lower error limit depends on the installation situation, specified value refers to a symmetrical position, i.e. deviation in upper and lower direction is the same.

²⁾ In accordance with DIN ISO 55350-13; 68.3% of the measured values are inside the specified area.

Interfaces

Communication interface	SSI
Initialization time	50 ms ¹⁾
Position forming time	< 1 μ s
Code type	Gray
Code sequence parameter adjustable	CW/CCW (V/R) parameter adjustable
Clock frequency	\leq 1 MHz ²⁾
Set (electronic adjustment)	H-active (L = 0 - 3 V, H = 4,0 - U _s V)
CW/CCW (counting sequence when turning)	L-active (L = 0 - 1,5 V, H = 2,0 - U _s V)

¹⁾ Valid positional data can be read once this time has elapsed.

²⁾ Minimum, LOW level (Clock +): 250 ns.

Electronics

Connection type	Male connector, M23, 12-pin, radial
Supply voltage	4.5 ... 32 V
Power consumption	≤ 0.7 W (without load)
Reverse polarity protection	✓

Mechanics

Mechanical design	Solid shaft, face mount flange
Shaft diameter	10 mm
Shaft length	19 mm
Characteristics of the shaft	With flat
Weight	0.3 kg ¹⁾
Shaft material	Stainless steel
Flange material	Aluminum
Housing material	Aluminum die cast
Start up torque	< 0.5 Ncm (+20 °C)
Operating torque	< 0.3 Ncm (+20 °C)
Permissible shaft loading	80 N (radial) 40 N (axial)
Operating speed	≤ 9,000 min ⁻¹ ²⁾
Moment of inertia of the rotor	6.2 gcm ²
Bearing lifetime	3.0 x 10 ⁹ revolutions
Angular acceleration	≤ 500,000 rad/s ²

¹⁾ Based on devices with male connector.

²⁾ Allow for self-heating of 3.3 K per 1,000 rpm when designing the operating temperature range.

Ambient data

EMC	According to EN 61000-6-2 and EN 61000-6-3 ¹⁾
Enclosure rating	IP65, shaft side (IEC 60529) IP67, housing side (IEC 60529) ²⁾
Permissible relative humidity	90 % (Condensation not permitted)
Operating temperature range	0 °C ... +85 °C
Storage temperature range	-40 °C ... +100 °C, without package
Resistance to shocks	50 g, 6 ms (EN 60068-2-27)
Resistance to vibration	20 g, 10 Hz ... 2,000 Hz (EN 60068-2-6)

¹⁾ EMC according to the standards quoted is achieved if shielded cables are used.

²⁾ For devices with male connector: with mounted mating connector.

Certificates

EU declaration of conformity	✓
UK declaration of conformity	✓
ACMA declaration of conformity	✓
Moroccan declaration of conformity	✓
China RoHS	✓

cULus certificate	✓
Information according to Art. 3 of Data Act (Regulation EU 2023/2854)	✓

Classifications

ECLASS 5.0	27270502
ECLASS 5.1.4	27270502
ECLASS 6.0	27270590
ECLASS 6.2	27270590
ECLASS 7.0	27270502
ECLASS 8.0	27270502
ECLASS 8.1	27270502
ECLASS 9.0	27270502
ECLASS 10.0	27270502
ECLASS 11.0	27270502
ECLASS 12.0	27270502
ETIM 5.0	EC001486
ETIM 6.0	EC001486
ETIM 7.0	EC001486
ETIM 8.0	EC001486
UNSPSC 16.0901	41112113

SpareCruX

Dimensional drawing

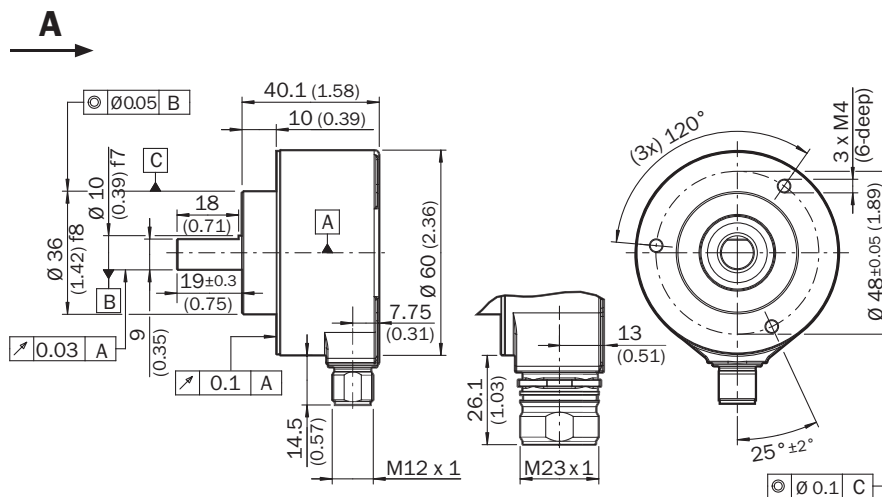

Dimensions in mm (inch)

Anschlussbelegung M23 male connector, 12-pin, SSI/Gray

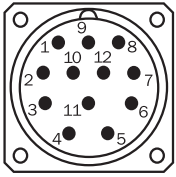

view of M23 male device connector on encoder

PIN	Signal	Explanation
1	GND	Ground connection
2	Data +	Interface signals
3	Clock +	Interface signals
4	N.C.	Not assigned
5	N.C.	Not assigned
6	N.C.	Not assigned
7	N.C.	Not assigned
8	U _S	Operating voltage
9	SET	Electronic adjustment
10	Data -	Interface signals
11	Clock -	Interface signals
12	V/R	Sequence in direction of rotation
-	Shielding	Screen connected to housing on encoder side. Connected to ground on control side.

SpareCruX

Diagrams

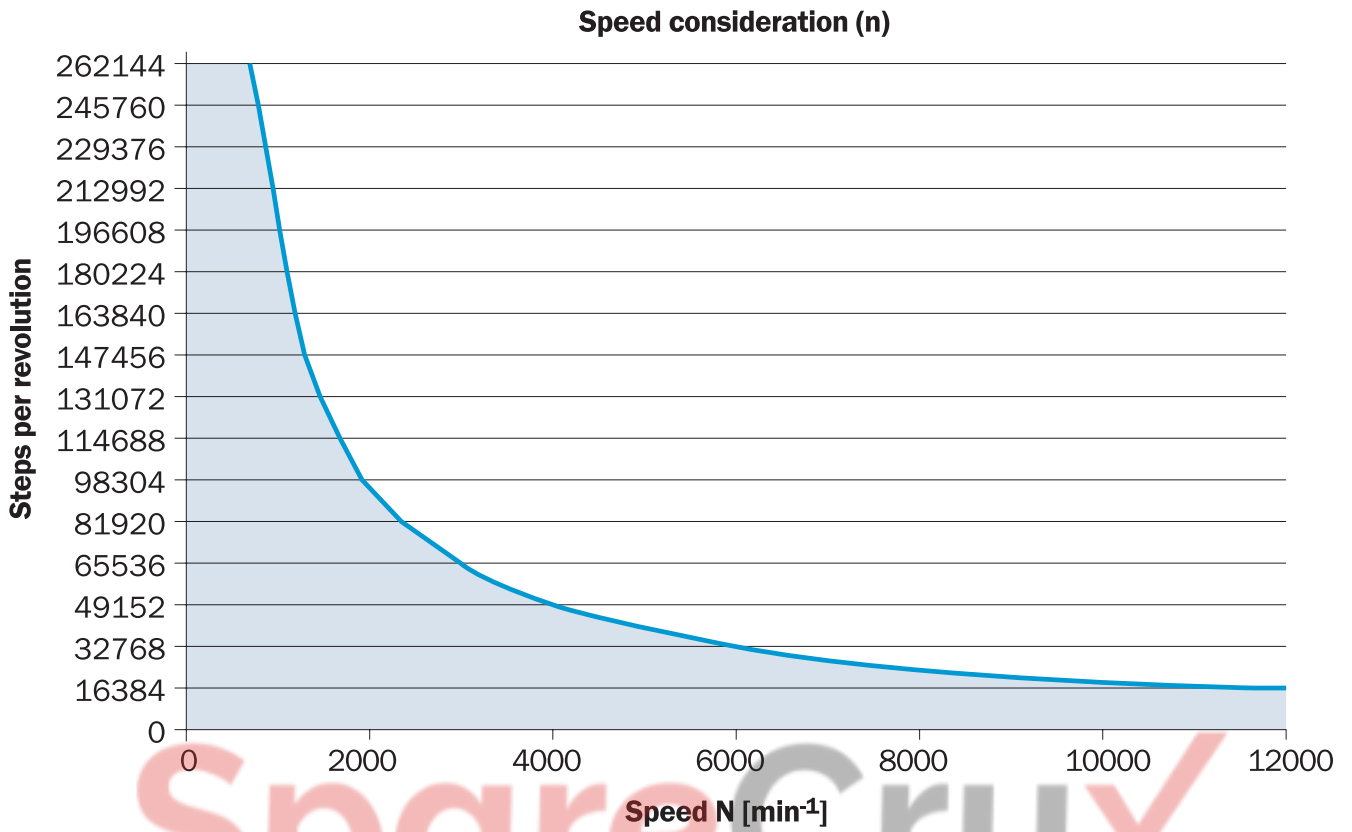







The maximum speed is also dependent on the shaft type.

Recommended accessories

Other models and accessories → www.sick.com/AFS_AFM60_SSI

	Brief description	Type	part no.
shaft adaptation			
	<ul style="list-style-type: none"> Product segment: Shaft adaptation Product: Shaft couplings Description: Bellows coupling, shaft diameter 6 mm / 10 mm, maximum shaft offset: radial ± 0.25 mm, axial ± 0.4 mm, angular +/- 4°; max. speed 10,000 rpm, -30 °C to +120 °C, max. torque 120 Ncm; material: stainless steel bellows, aluminum hub 	KUP-0610-B	5312982
	<ul style="list-style-type: none"> Product segment: Shaft adaptation Product: Shaft couplings Description: Double loop coupling, shaft diameter 6 mm / 10 mm, max. shaft offset: radially +/- 2,5 mm, axially +/- 3 mm, angle +/- 10 degrees; max. speed 3.000 rpm, -30 to +80 degrees Celsius, torsional spring stiffness of 25 Nm/rad 	KUP-0610-D	5326697
	<ul style="list-style-type: none"> Product segment: Shaft adaptation Product: Shaft couplings Description: Spring washer coupling, shaft diameter 6 mm / 10 mm, Maximum shaft offset: radial +/- 0.3 mm, axial +/- 0.4 mm, angular +/- 2.5°; max. speed 12,000 rpm, -10° to +80 °C, max. torque 60 Ncm; material: aluminum flange, glass fiber-reinforced polyamide membrane and hardened steel coupling pin 	KUP-0610-F	5312985
	<ul style="list-style-type: none"> Product segment: Shaft adaptation Product: Shaft couplings Description: Bar coupling, shaft diameter 6 mm / 10 mm, max. shaft offset: radial ± 0,3 mm, axial ± 0,3 mm, angular ± 3°; max. speed 10.000 rpm, -10° to +80 °C, max. torque: 80 Ncm, material: fiber-glass reinforced polyamide, aluminum hub 	KUP-0610-S	2056407
	<ul style="list-style-type: none"> Product segment: Shaft adaptation Product: Shaft couplings Description: Claw coupling, shaft diameter 6 mm / 10 mm, damping element 80 shore blue, maximum shaft offset: radial ± 0.22 mm, axial ± 1 mm angular ± 1.3°, max. speed 19,000 rpm, angle of twist max. 10°, -30 °C to +80 °C, max. torque 800 Ncm, tightening torque of screws: ISO 4029 150 Ncm, material: aluminum flange, damping element: polyurethane 	KUP-0610-J	2127056
	<ul style="list-style-type: none"> Product segment: Shaft adaptation Product: Shaft couplings Description: Double loop coupling, shaft diameter 8 mm / 10 mm, max. shaft offset: radially +/- 0,25 mm, axially +/- 0,4 mm, angle +/- 4 degrees; max. speed 10.000 rpm, -30 to +120 degrees Celsius, torsional spring stiffness of 150 Nm/rad 	KUP-0810-D	5326704
	<ul style="list-style-type: none"> Product segment: Shaft adaptation Product: Shaft couplings Description: Bar coupling, shaft diameter 8 mm / 10 mm, max. shaft offset: radial ± 0,3 mm, axial ± 0,3 mm, angular ± 3°; max. speed 10.000 rpm, -10° to +80 °C, max. torque: 80 Ncm, material: fiber-glass reinforced polyamide, aluminum hub 	KUP-0810-S	5314178
	<ul style="list-style-type: none"> Product segment: Shaft adaptation Product: Shaft couplings Description: Bellows coupling, shaft diameter 10 mm/10 mm; maximum shaft offset: radial +/- 0.25 mm, axial +/- 0.4 mm, angular +/- 4°; max. revolutions 10,000 rpm, -30° to +120 °C, max. torque 120 Ncm; material: stainless steel bellows, aluminum clamping hubs 	KUP-1010-B	5312983
	<ul style="list-style-type: none"> Product segment: Shaft adaptation Product: Shaft couplings Description: Double loop coupling, shaft diameter 10 mm / 10 mm, Maximum shaft offset: radial +/- 2.5 mm, axial +/- 3 mm, angular +/- 10°; max. speed 3,000 rpm, -30° to +80 °C, max. torque 1.5 Nm; material: polyurethane, galvanized steel flange 	KUP-1010-D	5326703
	<ul style="list-style-type: none"> Product segment: Shaft adaptation Product: Shaft couplings Description: Spring washer coupling, shaft diameter 10 mm / 10 mm, maximum shaft offset, radial ± 0.3 mm, axial ± 0.4 mm, angle ± 2.5°, torsion spring stiffness 30 Nm/rad; material: aluminum flange, glass-fiber reinforced polyamide membrane and hardened steel coupling pin 	KUP-1010-F	5312986
	<ul style="list-style-type: none"> Product segment: Shaft adaptation Product: Shaft couplings Description: Bar coupling, shaft diameter 10 mm / 10 mm; maximum shaft offset: radial ± 0.3 mm, axial ± 0.2 mm, angular ± 3°; speed 10,000 rpm, -10° to +80° Celsius, max. torque 80 Ncm; material: glass fiber-reinforced polyamide, aluminum hub 	KUP-1010-S	2056408
	<ul style="list-style-type: none"> Product segment: Shaft adaptation Product: Shaft couplings Description: Spring coupling, shaft diameter 10 mm / 10 mm, maximum shaft offset: radial ± 1.5 mm, axial ± 1.0 mm, angular ± 5°, max. speed 3,000 rpm, -30° to +120 °Celsius, nominal torque 150 Ncm, rotational angle at half nominal torque, direction of rotation right viewed on 	KUP-1010-W	5319914

	Brief description	Type	part no.
	<p>driving shaft 40°, left viewed on driving shaft 60°, material: spring steel 1.0600 nickel plated, zinc die cast hubs</p> <ul style="list-style-type: none"> Product segment: Shaft adaptation Product: Shaft couplings Description: 10 mm / 12 mm; maximum shaft offset: radial +/- 0.25 mm, axial +/- 0.4 mm, angular +/- 4°; max. revolutions 10,000 rpm, -30° to +120 °C, max. torque 120 Ncm; material: stainless steel bellows, aluminum clamping hubs 	KUP-1012-B	5312984
	<ul style="list-style-type: none"> Product segment: Shaft adaptation Product: Shaft couplings Description: Double loop coupling, shaft diameter 10 mm / 12 mm, Maximum shaft offset: radial +/- 2.5 mm, axial +/- 3 mm, angular +/- 10°; max. speed 3,000 rpm, -30° to +80 °C, max. torque 1.5 Nm; material: polyurethane, galvanized steel flange 	KUP-1012-D	5326702
	<ul style="list-style-type: none"> Product segment: Shaft adaptation Product: Shaft couplings Description: Claw coupling, shaft diameter 8 mm / 10 mm, damping element 80 shore blue, maximum shaft offset: radial ± 1 mm angular ± 1.3°, max. speed 19,000 rpm, angle of twist max. 10°, -30 °C to +80 °C, max. torque 800 Ncm, tightening torque of screws: ISO 4029 150 Ncm, material: aluminum flange, damping element: polyurethane 	KUP-0810-J	2128267
	<ul style="list-style-type: none"> Product segment: Shaft adaptation Product: Shaft couplings Description: Claw coupling, shaft diameter 10 mm / 10 mm, damping element 80 shore blue, maximum shaft offset: radial ± 0.22 mm, axial ± 1 mm angular ± 1.3°, max. speed 19,000 rpm, angle of twist max. 10°, -30 °C to +80 °C, max. torque 800 Ncm, tightening torque of screws: ISO 4029 150 Ncm, material: aluminum flange, damping element: polyurethane 	KUP-1010-J	2127054
	<ul style="list-style-type: none"> Product segment: Shaft adaptation Product: Shaft couplings Description: Claw coupling, shaft diameter 10 mm / 12 mm, damping element 80 shore blue, maximum shaft offset: radial ± 0.22 mm, axial ± 1 mm angular ± 1.3°, max. speed 19,000 rpm, angle of twist max. 10°, -30 °C to +80 °C, max. torque 800 Ncm, tightening torque of screws: ISO 4029 150 Ncm, material: aluminum flange, damping element: polyurethane 	KUP-1012-J	2128265
Mounting systems			
	<ul style="list-style-type: none"> Description: Servo clamps, large, for servo flange (clamps, eccentric fastener), 3 pcs, without mounting material Items supplied: Without mounting hardware 	BEF-WK-SF	2029166
	<ul style="list-style-type: none"> Description: Flange adapter, adaptation of face mount flange with 36 mm centering hub to 100 mm servo flange with 60 mm centering hub, aluminum Material: Aluminum Details: Aluminum 	BEF-FA-036-100	2029161

	Brief description	Type	part no.
connectors and cables			
	<ul style="list-style-type: none"> • Connection type head A: Flying leads • Connection type head B: Flying leads • Signal type: SSI, Incremental, HIPERFACE® • Items supplied: By the meter • Cable: 8-wire, PUR, halogen-free • Description: SSI, shielded, Incremental, HIPERFACE® 	LTG-2308-MWENC	6027529
	<ul style="list-style-type: none"> • Connection type head A: Female connector, M23, 12-pin, angled, A-coded • Signal type: HIPERFACE®, SSI, Incremental • Description: HIPERFACE®, shieldedSSIIncremental • Connection systems: Solder connection 	DOS-2312-W01	2072580
	<ul style="list-style-type: none"> • Connection type head A: Female connector, M23, 12-pin, straight, A-coded • Signal type: HIPERFACE®, SSI, Incremental • Description: HIPERFACE®, shieldedSSIIncremental • Connection systems: Solder connection 	DOS-2312-G02	2077057
	<ul style="list-style-type: none"> • Connection type head A: Female connector, M23, 12-pin, straight, A-coded • Signal type: HIPERFACE®, SSI, Incremental • Description: HIPERFACE®, shieldedSSIIncremental • Connection systems: Solder connection 	DOS-2312-G	6027538
	<ul style="list-style-type: none"> • Connection type head A: Female connector, M23, 12-pin, straight • Connection type head B: Flying leads • Signal type: SSI • Cable: 0.5 m, 8-wire, PUR, halogen-free • Description: SSI, shielded 	DOL-2308-G0M5AA6	2048595
	<ul style="list-style-type: none"> • Connection type head A: Female connector, M23, 12-pin, straight • Connection type head B: Flying leads • Signal type: SSI • Cable: 3 m, 8-wire, PUR, halogen-free • Description: SSI, shielded 	DOL-2308-G03MAA6	2048597
	<ul style="list-style-type: none"> • Connection type head A: Female connector, M23, 12-pin, straight • Connection type head B: Flying leads • Signal type: SSI • Cable: 5 m, 8-wire, PUR, halogen-free • Description: SSI, shielded 	DOL-2308-G05MAA6	2048598
	<ul style="list-style-type: none"> • Connection type head A: Female connector, M23, 12-pin, straight • Connection type head B: Flying leads • Signal type: SSI • Cable: 1.5 m, 8-wire, PUR, halogen-free • Description: SSI, shielded 	DOL-2308-G1M5AA6	2048596
	<ul style="list-style-type: none"> • Connection type head A: Female connector, M23, 12-pin, straight • Connection type head B: Flying leads • Signal type: SSI • Cable: 10 m, 8-wire, PUR, halogen-free • Description: SSI, shielded 	DOL-2308-G10MAA6	2048599
	<ul style="list-style-type: none"> • Connection type head A: Female connector, M23, 9-pin, straight, A-coded • Signal type: HIPERFACE®, SSI, Incremental • Description: HIPERFACE®, shieldedSSIIncremental • Connection systems: Solder connection 	DOS-2309-G	6028533

SICK AT A GLANCE

SICK is one of the leading manufacturers of intelligent sensors and sensor solutions for industrial applications. A unique range of products and services creates the perfect basis for controlling processes securely and efficiently, protecting individuals from accidents and preventing damage to the environment.

We have extensive experience in a wide range of industries and understand their processes and requirements. With intelligent sensors, we can deliver exactly what our customers need. In application centers in Europe, Asia and North America, system solutions are tested and optimized in accordance with customer specifications. All this makes us a reliable supplier and development partner.

Comprehensive services complete our offering: SICK LifeTime Services provide support throughout the machine life cycle and ensure safety and productivity.

For us, that is “Sensor Intelligence.”

WORLDWIDE PRESENCE:

Contacts and other locations – www.sick.com

SpareCruX