



SparecruX

# IME18-12NNSZC0S

IME

INDUCTIVE PROXIMITY SENSORS

**SICK**  
Sensor Intelligence.



### Ordering information

| Type            | part no. |
|-----------------|----------|
| IME18-12NNSZC0S | 1040990  |

**Included in delivery:** BEF-MU-M18 (1)

Other models and accessories → [www.sick.com/IME](http://www.sick.com/IME)



### Detailed technical data

#### Features

|  |   |
|--|---|
| <b>Housing</b>                             | Metric                                  |
| <b>Housing</b>                             | Standard design                         |
| <b>Thread size</b>                         | M18 x 1                                 |
| <b>Diameter</b>                            | Ø 18 mm                                 |
| <b>Sensing range <math>S_n</math></b>      | 12 mm                                   |
| <b>Safe sensing range <math>S_a</math></b> | 9.72 mm                                 |
| <b>Installation type</b>                   | Non-flush                               |
| <b>Switching frequency</b>                 | 1,000 Hz                                |
| <b>Connection type</b>                     | Male connector M12, 4-pin               |
| <b>Switching output</b>                    | NPN                                     |
| <b>Switching output detail</b>             | NPN                                     |
| <b>Output function</b>                     | NO                                      |
| <b>Electrical wiring</b>                   | DC 3-wire                               |
| <b>Enclosure rating</b>                    | IP67 <sup>1)</sup>                      |
| <b>Items supplied</b>                      | Mounting nut, brass, nickel-plated (2x) |

<sup>1)</sup> According to EN 60529.

#### Mechanics/electronics

|                       |                     |
|-----------------------|---------------------|
| <b>Supply voltage</b> | 10 V DC ... 30 V DC |
| <b>Ripple</b>         | ≤ 10 %              |
| <b>Voltage drop</b>   | ≤ 2 V <sup>1)</sup> |

<sup>1)</sup> At  $I_a$  max.

<sup>2)</sup> Supply voltage  $U_B$  and constant ambient temperature  $T_a$ .

<sup>3)</sup> Of  $S_r$ .

|   |                                      |
|---|--------------------------------------|
| <b>Time delay before availability</b>       | ≤ 100 ms                             |
| <b>Hysteresis</b>                           | 5 % ... 15 %                         |
| <b>Reproducibility</b>                      | ≤ 2 % <sup>2)</sup><br><sup>3)</sup> |
| <b>Temperature drift (of S<sub>r</sub>)</b> | ± 10 %                               |
| <b>EMC</b>                                  | According to EN 60947-5-2            |
| <b>Continuous current I<sub>a</sub></b>     | ≤ 200 mA                             |
| <b>No load current</b>                      | ≤ 10 mA                              |
| <b>Short-circuit protection</b>             | ✓                                    |
| <b>Power-up pulse protection</b>            | ✓                                    |
| <b>Shock and vibration resistance</b>       | 30 g, 11 ms/10 Hz ... 55 Hz, 1 mm    |
| <b>Ambient operating temperature</b>        | -25 °C ... +75 °C                    |
| <b>Housing material</b>                     | Brass, nickel-plated                 |
| <b>Sensing face material</b>                | Plastic, PA 66                       |
| <b>Housing length</b>                       | 69 mm                                |
| <b>Thread length</b>                        | 42 mm                                |
| <b>Tightening torque, max.</b>              | ≤ 40 Nm                              |
| <b>UL File No.</b>                          | NRKH.E181493                         |

<sup>1)</sup> At I<sub>a</sub> max.

<sup>2)</sup> Supply voltage U<sub>B</sub> and constant ambient temperature T<sub>a</sub>.

<sup>3)</sup> Of S<sub>r</sub>.

#### Safety-related parameters

|                         |             |
|-------------------------|-------------|
| <b>MTTF<sub>D</sub></b> | 1,735 years |
| <b>DC<sub>avg</sub></b> | 0 %         |

#### Reduction factors

|                                   |  |
|-----------------------------------|--|
| <b>Note</b>                       | The values are reference values which may vary |
| <b>St37 steel (Fe)</b>            | 1  |
| <b>Stainless steel (V2A, 304)</b> | Approx. 0.8                                    |
| <b>Aluminum (Al)</b>              | Approx. 0.45                                   |
| <b>Copper (Cu)</b>                | Approx. 0.4                                    |
| <b>Brass (Br)</b>                 | Approx. 0.4                                    |

#### Installation note

|               |                                       |
|---------------|---------------------------------------|
| <b>Remark</b> | Associated graphic see "Installation" |
| <b>A</b>      | 18 mm                                 |
| <b>B</b>      | 36 mm                                 |
| <b>C</b>      | 18 mm                                 |
| <b>D</b>      | 36 mm                                 |
| <b>E</b>      | 24 mm                                 |
| <b>F</b>      | 96 mm                                 |

#### Certificates

|                                     |   |
|-------------------------------------|---|
| <b>EU declaration of conformity</b> | ✓ |
|-------------------------------------|---|

|   |   |
|---|---|
| <b>UK declaration of conformity</b>       | ✓ |
| <b>ACMA declaration of conformity</b>     | ✓ |
| <b>Moroccan declaration of conformity</b> | ✓ |
| <b>China RoHS</b>                         | ✓ |
| <b>cULus certificate</b>                  | ✓ |

Classifications

|                       |          |
|-----------------------|----------|
| <b>ECLASS 5.0</b>     | 27270101 |
| <b>ECLASS 5.1.4</b>   | 27270101 |
| <b>ECLASS 6.0</b>     | 27270101 |
| <b>ECLASS 6.2</b>     | 27270101 |
| <b>ECLASS 7.0</b>     | 27270101 |
| <b>ECLASS 8.0</b>     | 27270101 |
| <b>ECLASS 8.1</b>     | 27270101 |
| <b>ECLASS 9.0</b>     | 27270101 |
| <b>ECLASS 10.0</b>    | 27270101 |
| <b>ECLASS 11.0</b>    | 27270101 |
| <b>ECLASS 12.0</b>    | 27274001 |
| <b>ETIM 5.0</b>       | EC002714 |
| <b>ETIM 6.0</b>       | EC002714 |
| <b>ETIM 7.0</b>       | EC002714 |
| <b>ETIM 8.0</b>       | EC002714 |
| <b>UNSPSC 16.0901</b> | 39122230 |



Installation note Non-flush installation

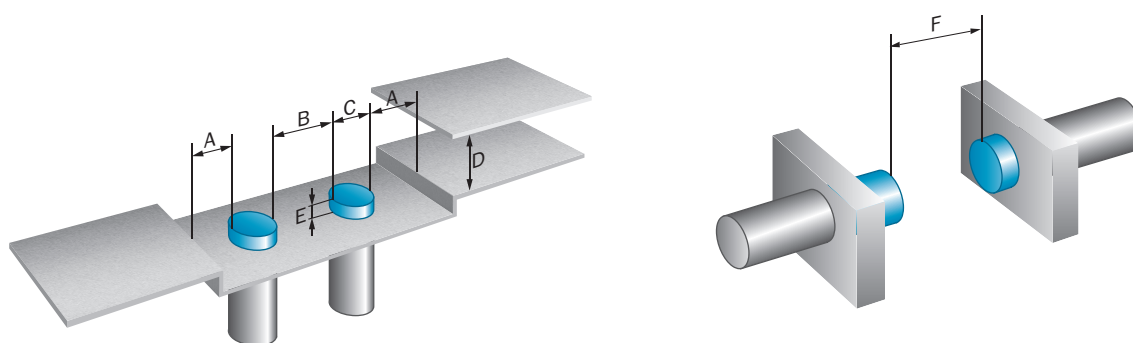

Connection type

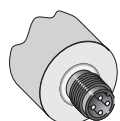

### Connection diagram Cd-007



### Dimensional drawing IME18 Standard, connector, non-flush

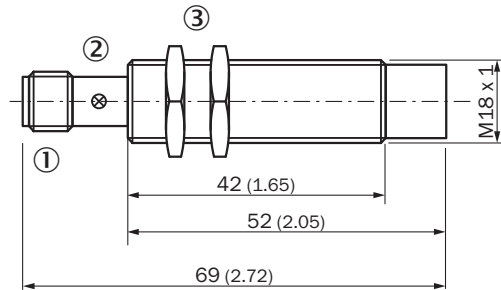





Dimensions in mm (inch)

- ① Connection
- ② Display LED
- ③ Fastening nuts (2x); width across 24, metal

SpareCruX

Recommended accessories

Other models and accessories → [www.sick.com/IME](http://www.sick.com/IME)

|  | Brief description  | Type        | part no. |
|--|--|-------------|----------|
| Mounting systems   |  |             |          |
|   | <ul style="list-style-type: none"> <li><b>Description:</b> Clamping block for round sensors M18, with fixed stop</li> <li><b>Material:</b> Plastic</li> <li><b>Details:</b> Plastic (PA12), glass-fiber reinforced</li> <li><b>Items supplied:</b> Mounting hardware included</li> <li><b>Suitable for:</b> GR18, MH15V, V180-2, V18</li> </ul>    | BEF-KHF-M18 | 2051482  |
|   | <ul style="list-style-type: none"> <li><b>Description:</b> Clamping block for round sensors M18, without fixed stop</li> <li><b>Material:</b> Plastic</li> <li><b>Details:</b> Plastic (PA12), glass-fiber reinforced</li> <li><b>Items supplied:</b> Mounting hardware included</li> <li><b>Suitable for:</b> GR18, MH15V, V180-2, V18</li> </ul> | BEF-KH-M18  | 2051481  |
|   | <ul style="list-style-type: none"> <li><b>Description:</b> Mounting plate for M18 sensors</li> <li><b>Material:</b> Steel</li> <li><b>Details:</b> Steel, zinc coated</li> <li><b>Items supplied:</b> Without mounting hardware</li> <li><b>Suitable for:</b> GR18, V180-2, V18, W15, Z1, Z2</li> </ul>  | BEF-WG-M18  | 5321870  |
|   | <ul style="list-style-type: none"> <li><b>Description:</b> Mounting bracket for M18 sensors</li> <li><b>Material:</b> Steel</li> <li><b>Details:</b> Steel, zinc coated</li> <li><b>Items supplied:</b> Without mounting hardware</li> <li><b>Suitable for:</b> GR18, V180-2, V18, W15, Z1, Z2</li> </ul>  | BEF-WN-M18  | 5308446  |
|  | <ul style="list-style-type: none"> <li><b>Description:</b> Mounting bracket for M18 sensors</li> <li><b>Material:</b> Stainless steel</li> <li><b>Details:</b> Stainless steel</li> <li><b>Items supplied:</b> Without mounting hardware</li> </ul>  | BEF-WN-M18N | 5320947  |

SparesCruX

|   | Brief description   | Type               | part no. |
|---|---|--------------------|----------|
| connectors and cables   |   |                    |          |
|    | <ul style="list-style-type: none"> <li><b>Connection type head A:</b> Female connector, M12, 4-pin, straight, A-coded</li> <li><b>Description:</b> Unshielded</li> <li><b>Connection systems:</b> Screw-type terminals</li> <li><b>Permitted cross-section:</b> ≤ 0.75 mm<sup>2</sup></li> </ul>  | DOS-1204-G         | 6007302  |
|    | <ul style="list-style-type: none"> <li><b>Connection type head A:</b> Female connector, M12, 4-pin, angled, A-coded</li> <li><b>Description:</b> Unshielded</li> <li><b>Connection systems:</b> Screw-type terminals</li> <li><b>Permitted cross-section:</b> ≤ 0.75 mm<sup>2</sup></li> </ul>  | DOS-1204-W         | 6007303  |
|    | <ul style="list-style-type: none"> <li><b>Connection type head A:</b> Female connector, M12, 4-pin, straight</li> <li><b>Connection type head B:</b> Flying leads</li> <li><b>Signal type:</b> Sensor/actuator cable</li> <li><b>Cable:</b> 5 m, 4-wire, PVC</li> <li><b>Description:</b> Sensor/actuator cable, unshielded</li> <li><b>Connection systems:</b> Flying leads</li> <li><b>Note:</b> This product is generally resistant to chemical cleaning agents (see ECOLAB). Please do not use cleaning agents of any other Kind., Not resistant against lactic acid &amp; hydrogen peroxide (H2O2)</li> <li><b>Application:</b> Hygienic and washdown zones</li> </ul>   | DOL-1204-G05MNI    | 6052615  |
|    | <ul style="list-style-type: none"> <li><b>Connection type head A:</b> Female connector, M12, 4-pin, straight</li> <li><b>Connection type head B:</b> Flying leads</li> <li><b>Signal type:</b> Sensor/actuator cable</li> <li><b>Cable:</b> 5 m, 4-wire, PP</li> <li><b>Description:</b> Sensor/actuator cable, unshielded</li> <li><b>Connection systems:</b> Flying leads</li> <li><b>Note:</b> This product is generally resistant to chemical cleaning agents (see ECOLAB) and other chemical compounds such as H2O2 and CH2O2. Before permanent installation is carried out, the material's resistance to the cleaning agent being used must be checked., Resistant against lactic acid &amp; hydrogen peroxide (H2O2)</li> <li><b>Application:</b> Hygienic and washdown zones, Drag chain operation</li> </ul> | DOL-1204-G05MRN    | 6058476  |
|   | <ul style="list-style-type: none"> <li><b>Connection type head A:</b> Female connector, M12, 4-pin, straight, A-coded</li> <li><b>Connection type head B:</b> Flying leads</li> <li><b>Signal type:</b> Sensor/actuator cable</li> <li><b>Cable:</b> 5 m, 4-wire, PVC</li> <li><b>Description:</b> Sensor/actuator cable, unshielded</li> <li><b>Application:</b> Zones with chemicals, Uncontaminated zones</li> </ul>   | YF2A14-050VB3XLEAX | 2096235  |
|  | <ul style="list-style-type: none"> <li><b>Connection type head A:</b> Female connector, M12, 4-pin, straight, A-coded</li> <li><b>Connection type head B:</b> Flying leads</li> <li><b>Signal type:</b> Sensor/actuator cable</li> <li><b>Cable:</b> 5 m, 4-wire, PUR, halogen-free</li> <li><b>Description:</b> Sensor/actuator cable, unshielded</li> <li><b>Application:</b> Uncontaminated zones, Zones with oils and lubricants, Robot, Drag chain operation</li> </ul>  | YF2A14-050UB3XLEAX | 2095608  |
|  | <ul style="list-style-type: none"> <li><b>Connection type head A:</b> Female connector, M12, 4-pin, angled, A-coded</li> <li><b>Connection type head B:</b> Flying leads</li> <li><b>Signal type:</b> Sensor/actuator cable</li> <li><b>Cable:</b> 0.6 m, 4-wire, PVC</li> <li><b>Description:</b> Sensor/actuator cable, unshielded</li> <li><b>Application:</b> Zones with chemicals, Uncontaminated zones</li> </ul>   | YG2A14-C60VB3XLEAX | 2145709  |
|  | <ul style="list-style-type: none"> <li><b>Connection type head A:</b> Female connector, M12, 4-pin, angled, A-coded</li> <li><b>Connection type head B:</b> Flying leads</li> <li><b>Signal type:</b> Sensor/actuator cable</li> <li><b>Cable:</b> 1 m, 4-wire, PVC</li> <li><b>Description:</b> Sensor/actuator cable, unshielded</li> <li><b>Application:</b> Zones with chemicals, Uncontaminated zones</li> </ul>   | YG2A14-010VB3XLEAX | 2145710  |
|  | <ul style="list-style-type: none"> <li><b>Connection type head A:</b> Female connector, M12, 4-pin, straight, A-coded</li> <li><b>Connection type head B:</b> Flying leads</li> <li><b>Signal type:</b> Sensor/actuator cable</li> <li><b>Cable:</b> 0.6 m, 4-wire, PVC</li> <li><b>Description:</b> Sensor/actuator cable, unshielded</li> <li><b>Application:</b> Zones with chemicals, Uncontaminated zones</li> </ul>   | YF2A14-C60VB3XLEAX | 2145707  |
|  | <ul style="list-style-type: none"> <li><b>Connection type head A:</b> Female connector, M12, 4-pin, straight, A-coded</li> <li><b>Connection type head B:</b> Flying leads</li> <li><b>Signal type:</b> Sensor/actuator cable</li> <li><b>Cable:</b> 1 m, 4-wire, PVC</li> <li><b>Description:</b> Sensor/actuator cable, unshielded</li> <li><b>Application:</b> Zones with chemicals, Uncontaminated zones</li> </ul>   | YF2A14-010VB3XLEAX | 2145708  |

## SICK AT A GLANCE

SICK is one of the leading manufacturers of intelligent sensors and sensor solutions for industrial applications. A unique range of products and services creates the perfect basis for controlling processes securely and efficiently, protecting individuals from accidents and preventing damage to the environment.

We have extensive experience in a wide range of industries and understand their processes and requirements. With intelligent sensors, we can deliver exactly what our customers need. In application centers in Europe, Asia and North America, system solutions are tested and optimized in accordance with customer specifications. All this makes us a reliable supplier and development partner.

Comprehensive services complete our offering: SICK LifeTime Services provide support throughout the machine life cycle and ensure safety and productivity.

For us, that is “Sensor Intelligence.”

### WORLDWIDE PRESENCE:

Contacts and other locations – [www.sick.com](http://www.sick.com)

SpareCruX