



DT50-P2123

Dx50

TIME-OF-FLIGHT SENSORS

SICK
Sensor Intelligence.



Ordering information

Type	part no.
DT50-P2123	1047399

Other models and accessories → www.sick.com/Dx50

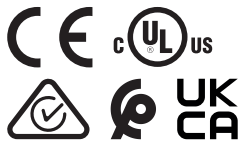

Detailed technical data

Features

Measuring range	200 mm ... 13,000 mm, 90% remission factor 200 mm ... 5,800 mm, 18% reflection factor 200 mm ... 3,400 mm, 6% remission factor
Target	Natural objects
Resolution	1,000 µm
Repeatability	≥ 1 mm ^{1) 2) 3)}
Measurement accuracy	± 7 mm ⁴⁾
Response time	15 ms ... 80 ms, 15 ms / 30 ms / 80 ms ^{3) 5)}
Output time	≥ 2 ms ⁶⁾
Emitted beam	
Light source	Laser, red
Type of light	Visible red light
Typ. light spot size (distance)	15 mm x 15 mm (10 m)
Key laser figures	
Normative reference	IEC 60825-1:2014, EN 60825-1:2014
Laser class	1 ⁷⁾
Average laser service life (at 25 °C)	100,000 h
Additional function	Set moving average fast/medium/slow Switching mode: distance to object (DtO) Teach-in, scaling and inversion of digital output

1) Equivalent to 1 σ.
 2) 6% ... 90% remission factor.
 3) Dependent on the averaging setting: fast/medium/slow.
 4) 90% remission factor.
 5) Lateral entry of the object into the measuring range.
 6) Continuous change of distance in measuring range.
 7) Wavelength: 658 nm; max. output: 120 mW; pulse duration: 2.5 ns; duty cycle: 1/400.

		Set hysteresis Teach-in, scaling and inversion of analog output Multifunctional input: laser off / external teach / deactivated Switch-off display Reset to factory default Lock user interface
Safety-related parameters	MTTF _D	101 years
	DC _{avg}	0%

- 1) Equivalent to 1 σ .
- 2) 6% ... 90% remission factor.
- 3) Dependent on the averaging setting: fast/medium/slow.
- 4) 90% remission factor.
- 5) Lateral entry of the object into the measuring range.
- 6) Continuous change of distance in measuring range.
- 7) Wavelength: 658 nm; max. output: 120 mW; pulse duration: 2.5 ns; duty cycle: 1/400.

Interfaces

Digital output	Number	1 ^{1) 2)}
	Type	PNP
	Maximum output current I _A	≤ 100 mA
Analog output	Number	1
	Type	Current output
	Current	4 mA ... 20 mA, ≤ 300 Ω
	Resolution	16 bit
Multifunctional input (MF)		1 x ^{3) 4)}
Hysteresis		10 mm ... 1,000 mm

- 1) Output Q short-circuit protected.
- 2) PNP: HIGH = V_S - (< 2.5 V) / LOW = 0 V.
- 3) Response time ≤ 15ms.
- 4) PNP: HIGH = V_S / LOW = ≤ 2.5 V.

Electronics

Supply voltage U_B	DC 10 V ... 30 V ¹⁾
Power consumption	≤ 2.1 W ²⁾
Ripple	≤ 5 V _{pp} ³⁾
Initialization time	≤ 250 ms
Warm-up time	≤ 15 min
Display	LC display, 2 x LED
Enclosure rating	IP65
Protection class	III
Connection type	

- 1) Limit values, reverse-polarity protected, operation in short-circuit protected network: max. 8 A.
- 2) Without load.
- 3) May not fall short of or exceed V_S tolerances.

	Male connector
--	----------------

- 1) Limit values, reverse-polarity protected, operation in short-circuit protected network: max. 8 A.
 2) Without load.
 3) May not fall short of or exceed V_S tolerances.

Mechanics

Dimensions (W x H x D)	36.1 mm x 62.7 mm x 57.7 mm
Housing material	Metal (zinc diecast)
Window material	Plastic (PMMA)
Weight	200 g

Ambient data

Ambient temperature, operation	-30 °C ... +65 °C -30 °C ... +80 °C, operation with 2 cooling plates -30 °C ... +140 °C, operation with 2 cooling plates and protection filter
Ambient temperature, storage	-40 °C ... +75 °C
Max. rel. humidity (not condensing)	≤ 95 %
Typ. Ambient light immunity	40,000 lx
Vibration resistance	EN 60068-2-6, EN 60068-2-64
Shock resistance	EN 60068-2-27

Classifications

ECLASS 5.0	27270801
ECLASS 5.1.4	27270801
ECLASS 6.0	27270801
ECLASS 6.2	27270801
ECLASS 7.0	27270801
ECLASS 8.0	27270801
ECLASS 8.1	27270801
ECLASS 9.0	27270801
ECLASS 10.0	27270801
ECLASS 11.0	27270801
ECLASS 12.0	27270916
ETIM 5.0	EC001825
ETIM 6.0	EC001825
ETIM 7.0	EC001825
ETIM 8.0	EC001825
UNSPSC 16.0901	41111613

Dimensional drawing

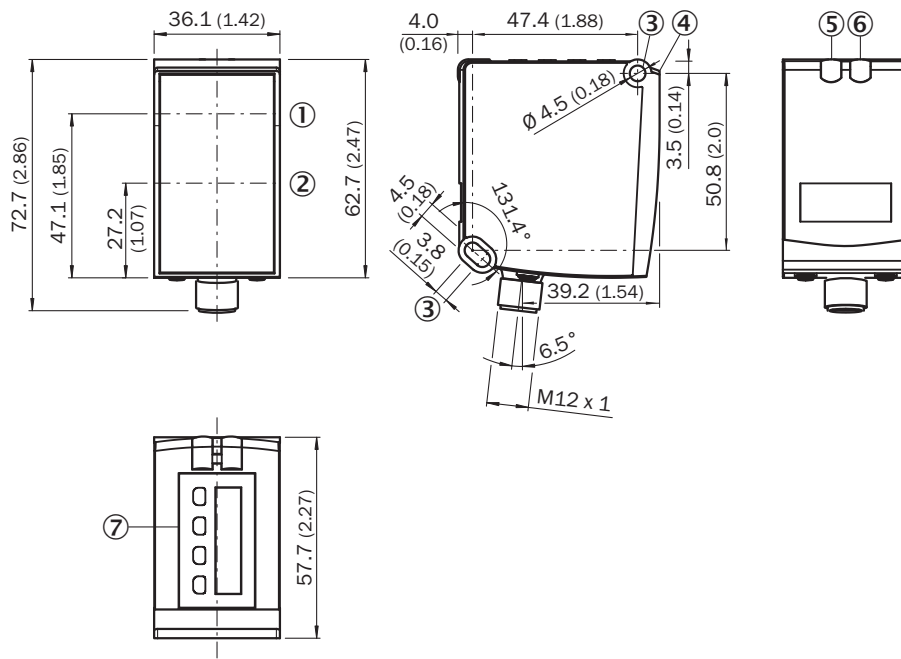

Dimensions in mm (inch)

- ① optical axis, sender
- ② optical axis, receiver
- ③ fixing hole
- ④ Reference surface = 0 mm
- ⑤ Status indicator digital output Q₁ (orange)
- ⑥ DT50/DT50 Hi/DL50: Status display for supply voltage active (green), DS50/DL50 Hi: Status display of digital output Q₂ (orange)
- ⑦ Control elements and display

Connection type Plug, M12, 5-pin

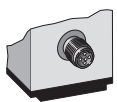

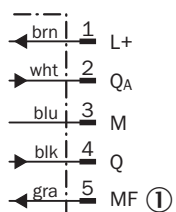

Connection diagram



- ① Multifunctional input (MF)

Recommended accessories

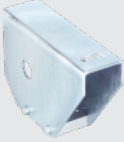
Other models and accessories → www.sick.com/Dx50

	Brief description	Type	part no.
device protection and care			
	<ul style="list-style-type: none"> Description: Weather Cover for Dx35/Dx50/Dx50-2/Dx80 	OBW-KHS-M02	2050205
	<ul style="list-style-type: none"> Description: Cooling plate for Dx50/Dx50-2/DT20 (for water cooling) Usable for: DT20 Hi, Dx50, Dx50-2 	BEF-KP-Dx50/DT20	2055755
	Strich		On request
Mounting systems			
	<ul style="list-style-type: none"> Description: Mounting bracket, steel, zinc coated Material: Steel Details: Steel, zinc coated Items supplied: Mounting hardware for the sensor included Suitable for: Dx50, Dx80, Dx50, Dx80 	BEF-WN-DX50	2048370

SpareCruX

	Brief description	Type	part no.
connectors and cables			
	<ul style="list-style-type: none"> • Connection type head A: Female connector, M12, 5-pin, angled, A-coded • Connection type head B: Flying leads • Signal type: Sensor/actuator cable • Cable: 2 m, 5-wire, PVC • Description: Sensor/actuator cable, unshielded • Application: Zones with chemicals, Uncontaminated zones 	YG2A15-020VB5XLEAX	2096215
	<ul style="list-style-type: none"> • Connection type head A: Female connector, M12, 5-pin, straight, A-coded • Connection type head B: Flying leads • Signal type: Sensor/actuator cable • Cable: 2 m, 5-wire, PVC • Description: Sensor/actuator cable, unshielded • Application: Zones with chemicals, Uncontaminated zones 	YF2A15-020VB5XLEAX	2096239
	<ul style="list-style-type: none"> • Connection type head A: Female connector, M12, 5-pin, angled, A-coded • Connection type head B: Flying leads • Signal type: Sensor/actuator cable • Cable: 0.6 m, 5-wire, PVC • Description: Sensor/actuator cable, unshielded • Application: Zones with chemicals, Uncontaminated zones 	YG2A15-C60VB5XLEAX	2145573
	<ul style="list-style-type: none"> • Connection type head A: Female connector, M12, 5-pin, angled, A-coded • Connection type head B: Flying leads • Signal type: Sensor/actuator cable • Cable: 1 m, 5-wire, PVC • Description: Sensor/actuator cable, unshielded • Application: Zones with chemicals, Uncontaminated zones 	YG2A15-010VB5XLEAX	2145574
	<ul style="list-style-type: none"> • Connection type head A: Female connector, M12, 5-pin, angled, A-coded • Connection type head B: Flying leads • Signal type: Sensor/actuator cable • Cable: 3 m, 5-wire, PVC • Description: Sensor/actuator cable, unshielded • Application: Zones with chemicals, Uncontaminated zones 	YG2A15-030VB5XLEAX	2145575
	<ul style="list-style-type: none"> • Connection type head A: Female connector, M12, 5-pin, straight, A-coded • Connection type head B: Flying leads • Signal type: Sensor/actuator cable • Cable: 0.6 m, 5-wire, PVC • Description: Sensor/actuator cable, unshielded • Application: Zones with chemicals, Uncontaminated zones 	YF2A15-C60VB5XLEAX	2145570
	<ul style="list-style-type: none"> • Connection type head A: Female connector, M12, 5-pin, straight, A-coded • Connection type head B: Flying leads • Signal type: Sensor/actuator cable • Cable: 3 m, 5-wire, PVC • Description: Sensor/actuator cable, unshielded • Application: Zones with chemicals, Uncontaminated zones 	YF2A15-030VB5XLEAX	2145572

SICK AT A GLANCE

SICK is one of the leading manufacturers of intelligent sensors and sensor solutions for industrial applications. A unique range of products and services creates the perfect basis for controlling processes securely and efficiently, protecting individuals from accidents and preventing damage to the environment.

We have extensive experience in a wide range of industries and understand their processes and requirements. With intelligent sensors, we can deliver exactly what our customers need. In application centers in Europe, Asia and North America, system solutions are tested and optimized in accordance with customer specifications. All this makes us a reliable supplier and development partner.

Comprehensive services complete our offering: SICK LifeTime Services provide support throughout the machine life cycle and ensure safety and productivity.

For us, that is “Sensor Intelligence.”

WORLDWIDE PRESENCE:

Contacts and other locations – www.sick.com

SpareCruX