



WSE4SL-3P2237

W4

PHOTOELECTRIC SENSORS

SICK
Sensor Intelligence.



Illustration may differ



Ordering information

Type	part no.
WSE4SL-3P2237	1058249

Other models and accessories → www.sick.com/W4

Detailed technical data

Features

Functional principle	Through-beam photoelectric sensor
Sensing range max.	0 m ... 60 m
Sensing range	0 m ... 50 m
Emitted beam	
Light source	Laser ¹⁾
Type of light	Visible red light
Light spot size (distance)	Ø 1 mm (500 mm)
Key laser figures	
Normative reference	EN 60825-1:2014, IEC 60825-1:2014 / CDRH 21 CFR 1040.10 & 1040.11
Laser class	1
Wave length	650 nm
Adjustment	Single teach-in button
Special applications	Detecting small objects
Part number of individual components	2064095 WS4SL-3D2236 2064097 WE4SL-3P2232
Mounting hole	M3

¹⁾ Average service life: 50,000 h at T_U = +25 °C.

Safety-related parameters

MTTF_D	355 years (EN ISO 13849-1) ¹⁾
DC_{avg}	0 %

¹⁾ Mode of calculation: Parts-Count-calculation.

Electronics

Supply voltage U_B	10 V DC ... 30 V DC ¹⁾
Ripple	< 5 V _{pp} ²⁾
Current consumption	30 mA ³⁾
Protection class	III
Digital output	
Type	PNP ⁴⁾
Switching mode	Light/dark switching ⁴⁾
Output current I_{max}	≤ 100 mA
Response time	≤ 0.5 ms ⁵⁾
Switching frequency	1,000 Hz ⁶⁾
Output function	Complementary
Circuit protection	A ⁷⁾ B ⁸⁾ C ⁹⁾

1) Limit values when operated in short-circuit protected network: max. 8 A.

2) May not fall below or exceed U_y tolerances.

3) Without load.

4) Q = light switching.

5) Signal transit time with resistive load.

6) With light/dark ratio 1:1.

7) A = V_S connections reverse-polarity protected.

8) B = inputs and output reverse-polarity protected.

9) C = interference suppression.

Mechanics

Housing	Rectangular
Design detail	Slim
Dimensions (W x H x D)	12.2 mm x 41.8 mm x 17.3 mm
Connection	Male connector M8, 4-pin
Material	
Housing	Plastic, Novodur
Front screen	Plastic, PMMA
Weight	100 g

Ambient data

Enclosure rating	IP66 IP67
Ambient operating temperature	-10 °C ... +50 °C
Ambient operating temperature extended	-30 °C ... +55 °C ^{1) 2)}
Ambient temperature, storage	-30 °C ... +70 °C

1) As of $T_a = 50$ °C, a max. supply voltage $V_{max} = 24$ V and a max. load current $I_{max} = 50$ mA is permitted.

2) Operation below $T_u -10$ °C is possible if the sensor is already switched on at $T_u > -10$ °C, then cools down, and the supply voltage is subsequently not switched off. Switching on below $T_u -10$ °C is not permissible.

Certificates

EU declaration of conformity	✓
UK declaration of conformity	✓
ACMA declaration of conformity	✓
Moroccan declaration of conformity	✓
China RoHS	✓
ECOLAB certificate	✓
Laser safety (IEC 60825-1) certificate	✓

Classifications

ECLASS 5.0	27270901
ECLASS 5.1.4	27270901
ECLASS 6.0	27270901
ECLASS 6.2	27270901
ECLASS 7.0	27270901
ECLASS 8.0	27270901
ECLASS 8.1	27270901
ECLASS 9.0	27270901
ECLASS 10.0	27270901
ECLASS 11.0	27270901
ECLASS 12.0	27270901
ETIM 5.0	EC002716
ETIM 6.0	EC002716
ETIM 7.0	EC002716
ETIM 8.0	EC002716
UNSPSC 16.0901	39121528

Connection diagram Cd-232

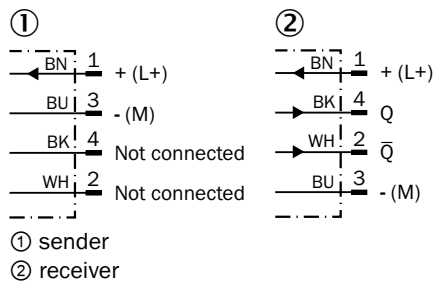

Characteristic curve

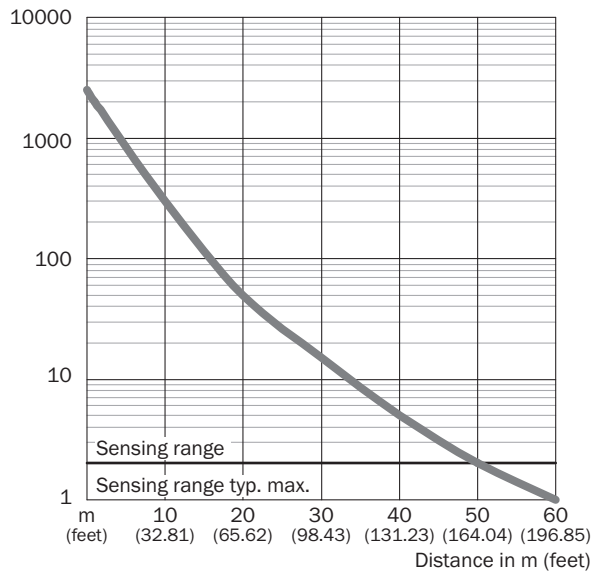

Light spot size



Dimensions in mm (inch)

Sensing range	Vertical	Horizontal
0.5 m (1.64 feet)	< 1.0 (0.04)	< 1.0 (0.04)
1 m (3.28 feet)	1.5 (0.06)	1.2 (0.05)
5 m (16.40 feet)	15 (0.59)	11 (0.43)
10 m (32.81 feet)	45 (1.77)	28 (1.10)
60 m (196.85 feet)	336 (13.23)	200 (7.87)

— Vertical
 — Horizontal

Light spot size (detailed view) Detailed view close range

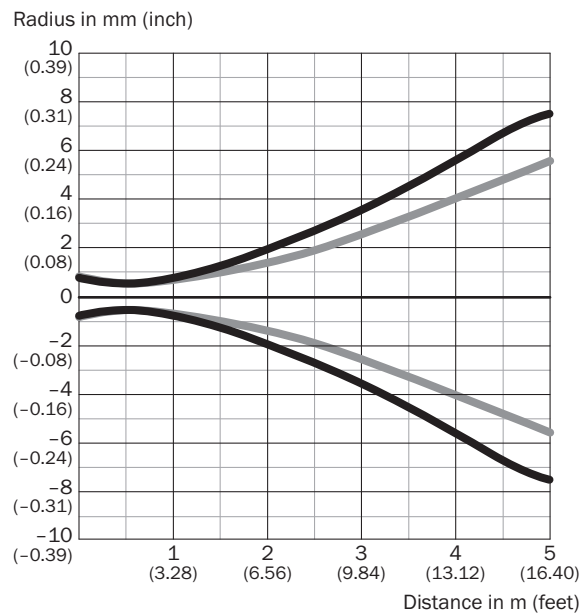

— Vertical
— Horizontal

Sensing range diagram

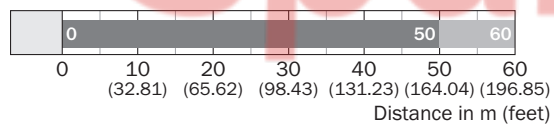

■ Sensing range ■ Sensing range typ. max.



Dimensional drawing WL4SL-3, WL4SLG-3, WSE4SL-3, plug

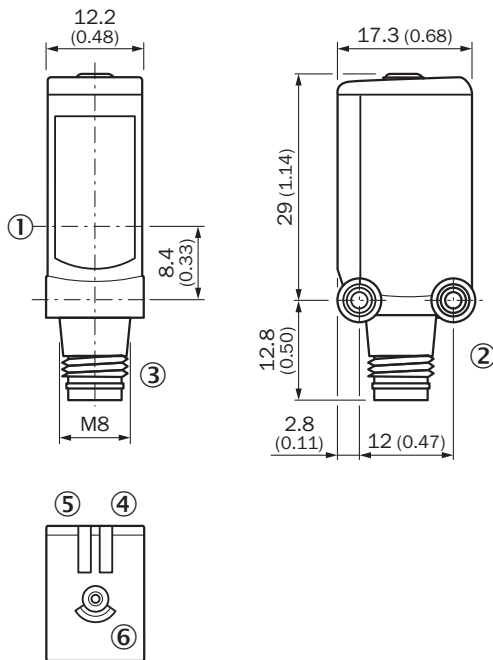



Dimensions in mm (inch)

- ① Center of optical axis
- ② Threaded mounting hole M3
- ③ Connection
- ④ LED indicator green: Supply voltage active
- ⑤ LED indicator yellow: Status of received light beam
- ⑥ single teach-in button



Recommended accessories

Other models and accessories → www.sick.com/W4

	Brief description	Type	part no.
connectors and cables			
	<ul style="list-style-type: none"> Connection type head A: Female connector, M8, 4-pin, straight, A-coded Connection type head B: Flying leads Signal type: Sensor/actuator cable Cable: 5 m, 4-wire, PVC Description: Sensor/actuator cable, unshielded Application: Zones with chemicals, Uncontaminated zones 	YF8U14-050VA3XLEAX	2095889
	<ul style="list-style-type: none"> Connection type head A: Male connector, M8, 4-pin, straight, A-coded Description: Unshielded Connection systems: Screw-type terminals Permitted cross-section: 0.14 mm² ... 0.5 mm² 	STE-0804-G	6037323
	<ul style="list-style-type: none"> Connection type head A: Female connector, M8, 4-pin, straight, A-coded Connection type head B: Flying leads Signal type: Sensor/actuator cable Cable: 5 m, 4-wire, PUR, halogen-free Description: Sensor/actuator cable, unshielded Application: Uncontaminated zones, Zones with oils and lubricants, Robot, Drag chain operation 	YF8U14-050UA3XLEAX	2094792

	Brief description	Type	part no.
Mounting systems			
	<ul style="list-style-type: none">• Description: Plate N11N for universal clamp bracket• Material: Stainless steel• Details: Stainless steel 1.4571 (sheet), Stainless steel 1.4408 (clamp)• Items supplied: Universal clamp (5322627), mounting hardware• Usable for: DeltaPac, Glare, WTD20E	BEF-KHS-N11N	2071081



SICK AT A GLANCE

SICK is one of the leading manufacturers of intelligent sensors and sensor solutions for industrial applications. A unique range of products and services creates the perfect basis for controlling processes securely and efficiently, protecting individuals from accidents and preventing damage to the environment.

We have extensive experience in a wide range of industries and understand their processes and requirements. With intelligent sensors, we can deliver exactly what our customers need. In application centers in Europe, Asia and North America, system solutions are tested and optimized in accordance with customer specifications. All this makes us a reliable supplier and development partner.

Comprehensive services complete our offering: SICK LifeTime Services provide support throughout the machine life cycle and ensure safety and productivity.

For us, that is “Sensor Intelligence.”

WORLDWIDE PRESENCE:

Contacts and other locations – www.sick.com

SpareCruX