



GTB10-R3822  
G10

SpareCruz

PHOTOELECTRIC SENSORS

**SICK**  
Sensor Intelligence.



Illustration may differ

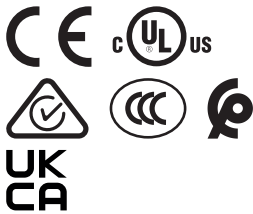

### Ordering information

Type	part no.
GTB10-R3822	1065864

**Included in delivery:** BEF-G10UC01 (1)

Other models and accessories → [www.sick.com/G10](http://www.sick.com/G10)

### Detailed technical data

#### Features

<b>Functional principle</b>	Photoelectric proximity sensor
<b>Functional principle detail</b>	Background suppression
<b>Dimensions (W x H x D)</b>	20 mm x 50 mm x 51.5 mm
<b>Housing design (light emission)</b>	Rectangular
<b>Sensing range max.</b>	20 mm ... 1,200 mm <sup>1)</sup>
<b>Type of light</b>	Infrared light
<b>Light source</b>	LED <sup>2)</sup>
<b>Light spot size (distance)</b>	Ø 22 mm (700 mm)
<b>Wave length</b>	850 nm
<b>Adjustment</b>	Potentiometer, 5 turns

<sup>1)</sup> Object with 90% remission (based on standard white, DIN 5033).

<sup>2)</sup> Average service life: 100,000 h at T<sub>J</sub> = +25 °C.

#### Mechanics/electronics

<b>Supply voltage U<sub>e</sub></b>	24 V AC/DC ... 240 V AC/DC <sup>1)</sup>
-------------------------------------	--

<sup>1)</sup> +- 10 %.

<sup>2)</sup> Provide suitable spark suppression for inductive or capacitive loads.

<sup>3)</sup> With light/dark ratio 1:1.

<sup>4)</sup> Do not bend below 0 °C.

<sup>5)</sup> C = interference suppression.

<sup>6)</sup> Reference voltage: 250 V AC.

<sup>7)</sup> In the case of a DC supply (ref. to EN 61000-6-3) the length of cable between the supply source and the sensor must be < 30 m.

<sup>8)</sup> UL: 0 °C ... +50 °C.

<sup>9)</sup> Complies with the UL325 standard when used with sturdy protection hood (e.g. BEF-G10WSG, 2071960).

<b>Ripple</b>	< 10 %
<b>Power consumption</b>	≤ 2.5 VA
<b>Switching output</b>	Relay, SPDT, electrically isolated <sup>2)</sup>
<b>Switching mode</b>	Light/dark switching <sup>2)</sup>
<b>Switching load max. (current/voltage)</b>	0.11 A (250 V DC) 3 A (30 V DC) 3 A (250 V AC)
<b>Response time</b>	≤ 10 ms
<b>Switching frequency</b>	20 Hz <sup>3)</sup>
<b>Connection type</b>	Cable, 5-wire, 2 m <sup>4)</sup>
<b>Cable material</b>	Plastic, PVC
<b>Conductor cross section</b>	0.25 mm <sup>2</sup>
<b>Circuit protection</b>	C <sup>5)</sup>
<b>Protection class</b>	II <sup>6)</sup>
<b>Weight</b>	115 g
<b>Interference emission</b>	EN 61000-6-3 (2011-09) <sup>7)</sup>
<b>Housing material</b>	Plastic, ABS/PMMA
<b>Enclosure rating</b>	IP67
<b>Relay switching cycles min.</b>	100.000 cycles (3 A)
<b>Items supplied</b>	Mounting bracket BEF-G10UC01
<b>Usage category</b>	DC-13 (according to EN 60947-1) AC-15 (according to EN 60947-1)
<b>Electromagnetic compatibility (EMC)</b>	EN 60947-5-2 EN 61000-6-3 (2011-09)
<b>Ambient operating temperature</b>	-30 °C ... +60 °C <sup>8)</sup>
<b>Ambient temperature, storage</b>	-40 °C ... +70 °C
<b>UL File No.</b>	NRKH.E348498 & NRKH7.E348498
<b>More standards</b>	UL325 <sup>9)</sup>

1) +/- 10 %.

2) Provide suitable spark suppression for inductive or capacitive loads.

3) With light/dark ratio 1:1.

4) Do not bend below 0 °C.

5) C = interference suppression.

6) Reference voltage: 250 V AC.

7) In the case of a DC supply (ref. to EN 61000-6-3) the length of cable between the supply source and the sensor must be < 30 m.

8) UL: 0 °C ... +50 °C.

9) Complies with the UL325 standard when used with sturdy protection hood (e.g. BEF-G10WSG, 2071960).

## Certificates

<b>EU declaration of conformity</b>	✓
<b>UK declaration of conformity</b>	✓
<b>ACMA declaration of conformity</b>	✓
<b>Moroccan declaration of conformity</b>	✓
<b>China RoHS</b>	✓
<b>CCC certificate</b>	✓

<b>cULus certificate</b>	✓
<b>Photobiological safety (DIN EN 62471) certificate</b>	✓

Classifications

<b>ECLASS 5.0</b>	27270904
<b>ECLASS 5.1.4</b>	27270904
<b>ECLASS 6.0</b>	27270904
<b>ECLASS 6.2</b>	27270904
<b>ECLASS 7.0</b>	27270904
<b>ECLASS 8.0</b>	27270904
<b>ECLASS 8.1</b>	27270904
<b>ECLASS 9.0</b>	27270904
<b>ECLASS 10.0</b>	27270904
<b>ECLASS 11.0</b>	27270904
<b>ECLASS 12.0</b>	27270903
<b>ETIM 5.0</b>	EC002719
<b>ETIM 6.0</b>	EC002719
<b>ETIM 7.0</b>	EC002719
<b>ETIM 8.0</b>	EC002719
<b>UNSPSC 16.0901</b>	39121528

Adjustments

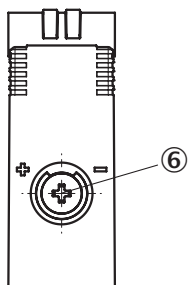

⑥ Adjustment of sensing range

SpareCruz

Connection diagram Cd-163

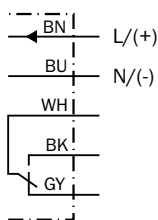

### scanning range

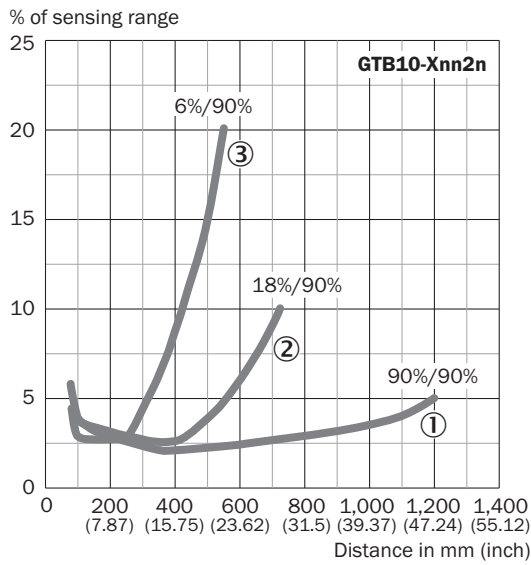

- ① Sensing range on white, 90% remission factor
- ② Sensing range on gray, 18% remission factor
- ③ Sensing range on black, 6% remission factor

### Light spot size

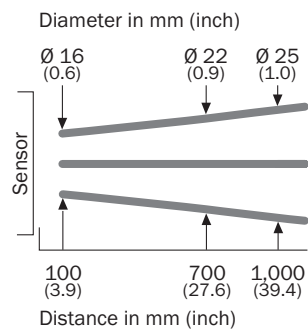

SpareCruz

### scanning range

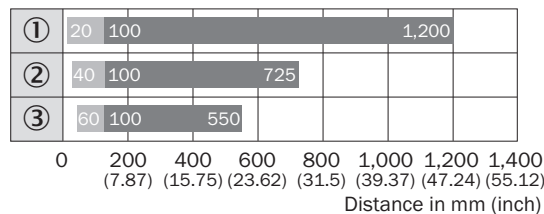

- Sensing range
- Sensing range max.
- ① Sensing range on white, 90% remission factor
- ② Sensing range on gray, 18% remission factor
- ③ Sensing range on black, 6% remission factor

Dimensional drawing GTB10, AC/DC, cable

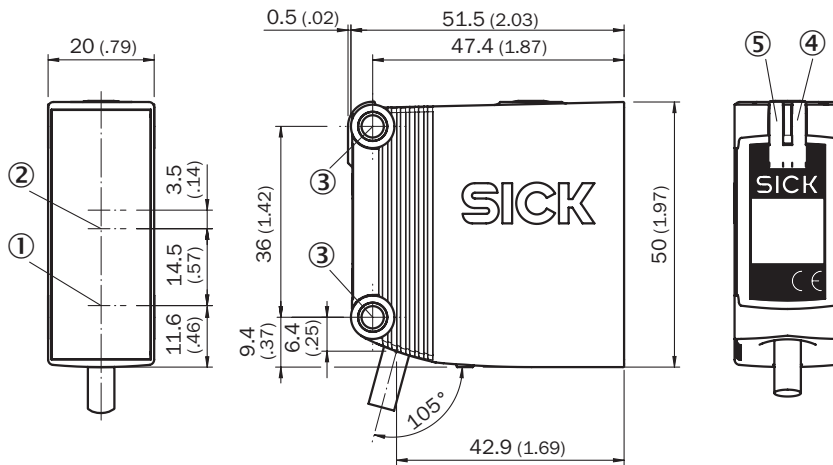



Dimensions in mm (inch)

- ① Center of optical axis, sender
- ② Center of optical axis, receiver
- ③ Mounting hole, Ø 4.2 mm
- ④ LED indicator yellow: Status of received light beam
- ⑤ LED indicator green: power on

Recommended accessories

Other models and accessories → [www.sick.com/G10](http://www.sick.com/G10)

	Brief description	Type	part no.
<b>Mounting systems</b>			
	<ul style="list-style-type: none"> <li>• <b>Description:</b> Q-Lock, bar clamp system for G10 and reflector P250</li> <li>• <b>Material:</b> Zinc diecast, steel</li> <li>• <b>Details:</b> Die-cast zinc, steel, zinc coated</li> <li>• <b>Suitable for:</b> G10 and reflector P250</li> </ul>	BEF-KHSQ12R01	2071260
	<ul style="list-style-type: none"> <li>• <b>Description:</b> Mounting bracket with articulated arm</li> <li>• <b>Material:</b> Steel</li> <li>• <b>Details:</b> Steel, zinc coated</li> <li>• <b>Items supplied:</b> Mounting hardware included</li> <li>• <b>Suitable for:</b> W16, W26, W11, W12, W23, W27, Dx50, W280, G10</li> </ul>	BEF-WN-MULTI2	2093945
<b>connectors and cables</b>			
	<ul style="list-style-type: none"> <li>• <b>Connection type head A:</b> Male connector, M12, 5-pin, straight, A-coded</li> <li>• <b>Description:</b> Unshielded</li> <li>• <b>Connection systems:</b> Screw-type terminals</li> <li>• <b>Permitted cross-section:</b> ≤ 0.75 mm<sup>2</sup></li> <li>• <b>Note:</b> For field bus technology</li> </ul>	STE-1205-G	6022083

## SICK AT A GLANCE

SICK is one of the leading manufacturers of intelligent sensors and sensor solutions for industrial applications. A unique range of products and services creates the perfect basis for controlling processes securely and efficiently, protecting individuals from accidents and preventing damage to the environment.

We have extensive experience in a wide range of industries and understand their processes and requirements. With intelligent sensors, we can deliver exactly what our customers need. In application centers in Europe, Asia and North America, system solutions are tested and optimized in accordance with customer specifications. All this makes us a reliable supplier and development partner.

Comprehensive services complete our offering: SICK LifeTime Services provide support throughout the machine life cycle and ensure safety and productivity.

For us, that is “Sensor Intelligence.”

## WORLDWIDE PRESENCE:

Contacts and other locations –[www.sick.com](http://www.sick.com)

SpareCruz