



GSE10-P4222
G10

SpareCruz

PHOTOELECTRIC SENSORS

SICK
Sensor Intelligence.



Ordering information

Type	part no.
GSE10-P4222	1065907

Included in delivery: BEF-G10DC01 (1)

Other models and accessories → www.sick.com/G10

Illustration may differ

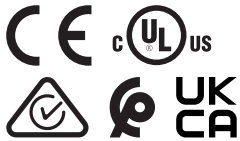

Detailed technical data

Features

Functional principle	Through-beam photoelectric sensor
Dimensions (W x H x D)	20 mm x 50 mm x 39 mm
Housing design (light emission)	Rectangular
Sensing range max.	0 m ... 40 m
Sensing range	0 m ... 35 m
Type of light	Infrared light
Light source	LED ¹⁾
Light spot size (distance)	Ø 433 mm (15 m)
Wave length	850 nm
Adjustment	Potentiometer, 270°

¹⁾ Average service life: 100,000 h at T_U = +25 °C.

Mechanics/electronics

Supply voltage U_B	10 V DC ... 30 V DC ¹⁾
Ripple	< 5 V _{pp} ²⁾
Power consumption, sender	≤ 15 mA
Power consumption, receiver	≤ 20 mA
Switching output	PNP
Switching mode	Light/dark switching

¹⁾ Limit values when operated in short-circuit protected network: max. 8 A.

²⁾ May not fall below or exceed U_V tolerances.

³⁾ Signal transit time with resistive load.

⁴⁾ With light/dark ratio 1:1.

⁵⁾ A = V_S connections reverse-polarity protected.

⁶⁾ B = inputs and output reverse-polarity protected.

⁷⁾ C = interference suppression.

⁸⁾ D = outputs overcurrent and short-circuit protected.

⁹⁾ Complies with the UL325 standard when used with sturdy protection hood (e.g. BEF-G10WSG, 2071960).

Switching mode selector	Selectable via light/dark selector
Output current I_{max}	≤ 100 mA
Response time	≤ 500 μs ³⁾
Switching frequency	1,000 Hz ⁴⁾
Connection type	Male connector M12, 4-pin
Circuit protection	A ⁵⁾ B ⁶⁾ C ⁷⁾ D ⁸⁾
Protection class	III
Weight	70 g
Housing material	Plastic, ABS/PMMA
Enclosure rating	IP67
Items supplied	Mounting bracket BEF-G10DC01 (2x)
Electromagnetic compatibility (EMC)	EN 60947-5-2
Test input	Sender OFF at "Test" 0 V
Ambient operating temperature	-30 °C ... +60 °C
Ambient temperature, storage	-40 °C ... +70 °C
UL File No.	NRKH.E348498 & NRKH7.E348498
More standards	UL325 ⁹⁾

1) Limit values when operated in short-circuit protected network: max. 8 A.

2) May not fall below or exceed U_y tolerances.

3) Signal transit time with resistive load.

4) With light/dark ratio 1:1.

5) A = V_S connections reverse-polarity protected.

6) B = inputs and output reverse-polarity protected.

7) C = interference suppression.

8) D = outputs overcurrent and short-circuit protected.

9) Complies with the UL325 standard when used with sturdy protection hood (e.g. BEF-G10WSG, 2071960).

Safety-related parameters

MTTF_D	863 years
DC_{avg}	0 %

Certificates

EU declaration of conformity	✓
UK declaration of conformity	✓
ACMA declaration of conformity	✓
Moroccan declaration of conformity	✓
China RoHS	✓
cULus certificate	✓
Photobiological safety (DIN EN 62471) certificate	✓

Classifications

ECLASS 5.0	27270901
-------------------	----------

ECLASS 5.1.4	27270901
ECLASS 6.0	27270901
ECLASS 6.2	27270901
ECLASS 7.0	27270901
ECLASS 8.0	27270901
ECLASS 8.1	27270901
ECLASS 9.0	27270901
ECLASS 10.0	27270901
ECLASS 11.0	27270901
ECLASS 12.0	27270901
ETIM 5.0	EC002716
ETIM 6.0	EC002716
ETIM 7.0	EC002716
ETIM 8.0	EC002716
UNSPSC 16.0901	39121528

Adjustments

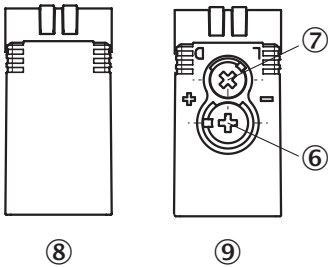

- ⑥ Adjustment of sensing range
- ⑦ Light/dark selector
- ⑧ sender
- ⑨ receiver

SpareCruz

Connection diagram Cd-073

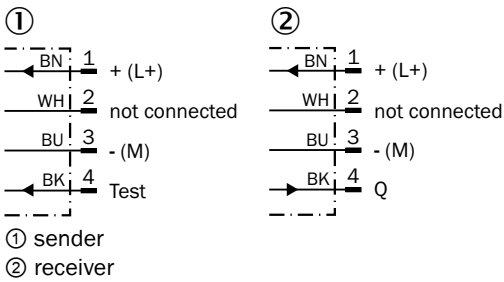

Operating reserve

Operating reserve

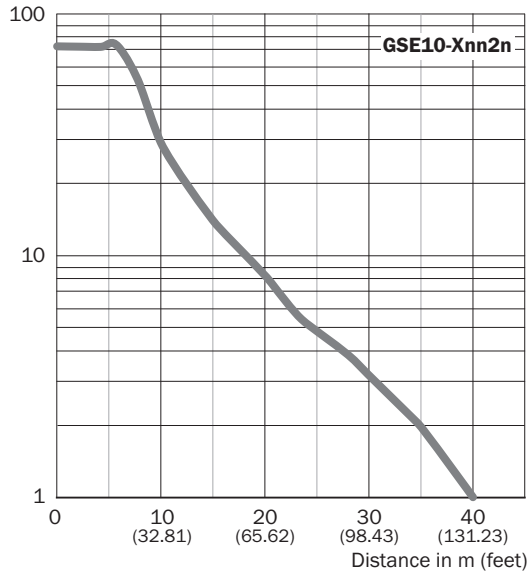

Light spot size

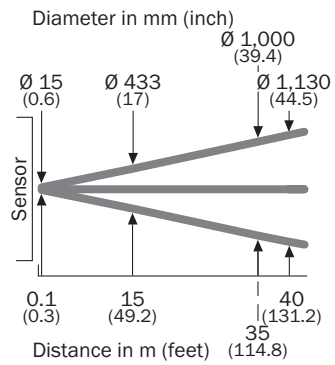

scanning range

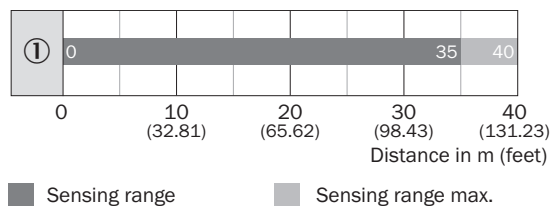

SpareCruz

Dimensional drawing GSE10, DC, connector

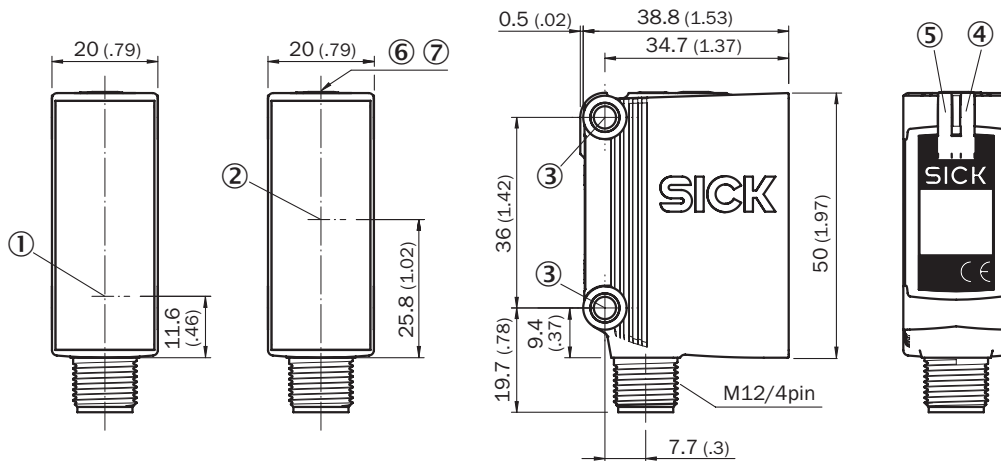



Dimensions in mm (inch)

- ① Center of optical axis, sender
- ② Center of optical axis, receiver
- ③ Mounting hole, Ø 4.2 mm
- ④ LED indicator yellow: Status of received light beam
- ⑤ LED indicator green: power on

Recommended accessories

Other models and accessories → www.sick.com/G10

	Brief description	Type	part no.
Mounting systems			
	<ul style="list-style-type: none"> • Description: Q-Lock, bar clamp system for G10 and reflector P250 • Material: Zinc diecast, steel • Details: Die-cast zinc, steel, zinc coated • Suitable for: G10 and reflector P250 	BEF-KHSQ12R01	2071260
	<ul style="list-style-type: none"> • Description: Mounting bracket with articulated arm • Material: Steel • Details: Steel, zinc coated • Items supplied: Mounting hardware included • Suitable for: W16, W26, W11, W12, W23, W27, Dx50, W280, G10 	BEF-WN-MULTI2	2093945

	Brief description	Type	part no.
connectors and cables			
	<ul style="list-style-type: none"> • Connection type head A: Female connector, M12, 4-pin, straight, A-coded • Connection type head B: Flying leads • Signal type: Sensor/actuator cable • Cable: 5 m, 4-wire, PVC • Description: Sensor/actuator cable, unshielded • Application: Zones with chemicals, Uncontaminated zones 	YF2A14-050VB3XLEAX	2096235
	<ul style="list-style-type: none"> • Connection type head A: Male connector, M12, 4-pin, straight, A-coded • Description: Unshielded • Connection systems: Screw-type terminals • Permitted cross-section: ≤ 0.75 mm² 	STE-1204-G	6009932
	<ul style="list-style-type: none"> • Connection type head A: Female connector, M12, 4-pin, straight, A-coded • Connection type head B: Flying leads • Signal type: Sensor/actuator cable • Cable: 5 m, 4-wire, PUR, halogen-free • Description: Sensor/actuator cable, unshielded • Application: Uncontaminated zones, Zones with oils and lubricants, Robot, Drag chain operation 	YF2A14-050UB3XLEAX	2095608

SpareCruX

SICK AT A GLANCE

SICK is one of the leading manufacturers of intelligent sensors and sensor solutions for industrial applications. A unique range of products and services creates the perfect basis for controlling processes securely and efficiently, protecting individuals from accidents and preventing damage to the environment.

We have extensive experience in a wide range of industries and understand their processes and requirements. With intelligent sensors, we can deliver exactly what our customers need. In application centers in Europe, Asia and North America, system solutions are tested and optimized in accordance with customer specifications. All this makes us a reliable supplier and development partner.

Comprehensive services complete our offering: SICK LifeTime Services provide support throughout the machine life cycle and ensure safety and productivity.

For us, that is “Sensor Intelligence.”

WORLDWIDE PRESENCE:

Contacts and other locations –www.sick.com

SpareCruz