



Sparecrux

# LUTM-UP817A2P

LUTM

LUMINESCENCE SENSORS

**SICK**  
Sensor Intelligence.



Illustration may differ

### Ordering information

Type	part no.
LUTM-UP817A2P	1067297

Other models and accessories → [www.sick.com/LUTM](http://www.sick.com/LUTM)



### Detailed technical data

#### Features

<b>Dimensions (W x H x D)</b>	12 mm x 31.5 mm x 21 mm
<b>Sensing distance</b>	≤ 12.5 mm <sup>1)</sup>
<b>Housing design</b>	Small
<b>Working range</b>	8 mm ... 20 mm
<b>Light source</b>	LED, UV <sup>2)</sup>
<b>Wave length</b>	370 nm
<b>Light emission</b>	Long side
<b>Light spot size</b>	2 mm x 2.5 mm <sup>3)</sup>
<b>Light spot direction</b>	Vertical
<b>Receiving range</b>	450 nm ... 750 nm
<b>Adjustment</b>	Cable, IO-Link
<b>Teach-in mode</b>	2-point teach-in static/dynamic
<b>Output function</b>	Light/dark switching <sup>4)</sup>

<sup>1)</sup> From leading edge of lens.

<sup>2)</sup> Average service life: 100,000 h at T<sub>J</sub> = +25 °C.

<sup>3)</sup> At sensing distance.

<sup>4)</sup> L/D switching via teach-in.

## Mechanics/electronics

<b>Supply voltage</b>	12 V DC ... 24 V DC <sup>1)</sup>
<b>Ripple</b>	$\leq 5 V_{pp}$ <sup>2)</sup>
<b>Current consumption</b>	$\leq 50 \text{ mA}$ <sup>3)</sup>
<b>Switching frequency</b>	6 kHz <sup>4)</sup>
<b>Response time</b>	80 $\mu\text{s}$ <sup>5)</sup>
<b>Jitter</b>	40 $\mu\text{s}$
<b>Switching output</b>	PNP
<b>Switching output (voltage)</b>	PNP: HIGH = $U_V \leq 2 \text{ V}$ / LOW approx. 0 V
<b>Switching mode</b>	Light/dark switching
<b>Output current <math>I_{max}</math></b>	$< 100 \text{ mA}$ <sup>6)</sup>
<b>Connection type</b>	Cable with M12 male connector, 4-pin, 0.2 m
<b>Protection class</b>	III
<b>Circuit protection</b>	$U_V$ connections, reverse polarity protected Output Q short-circuit protected Interference pulse suppression
<b>Enclosure rating</b>	IP67
<b>Weight</b>	70 g
<b>Housing material</b>	ABS

<sup>1)</sup> Limit values: DC 12 V (-10 %) ... DC 24 V (+20 %). Operation in short-circuit protected network max. 8 A.

<sup>2)</sup> May not fall below or exceed  $U_V$  tolerances.

<sup>3)</sup> Without load.

<sup>4)</sup> With light/dark ratio 1:1.

<sup>5)</sup> Signal transit time with resistive load.

<sup>6)</sup> At supply voltage  $> 24 \text{ V}$ ,  $I_{max} = 30 \text{ mA}$ .  $I_{max}$  is consumption count of all  $Q_n$ .

## Communication interface

<b>IO-Link</b>	✓, IO-Link V1.1
VendorID	26
DeviceID HEX	800072
DeviceID DEC	8388722
<b>Cycle time</b>	2.3 ms
<b>Process data structure A</b>	Bit 0 = switching signal $Q_{L1}$ Bit 1 = Quality of Run Alarm Bit 2 = Teach successful Bit 3 = Teach busy Bit 4 ... 15 = empty
<b>Process data structure B</b>	Bit 0 = switching signal $Q_{L1}$ Bit 1 = Quality of Run Alarm Bit 2 = Teach successful Bit 3 = Teach busy Bit 4 ... 15 = empty Bit 6 ... 15 = measuring value

## Ambient data

<b>Ambient operating temperature</b>	-10 °C ... +55 °C
<b>Ambient temperature, storage</b>	-20 °C ... +75 °C
<b>Shock load</b>	According to IEC 60068

<b>UL File No.</b>	NRKH.E348498 & NRKH7.E348498
--------------------	------------------------------

## Certificates

<b>EU declaration of conformity</b>	✓
<b>UK declaration of conformity</b>	✓
<b>ACMA declaration of conformity</b>	✓
<b>Moroccan declaration of conformity</b>	✓
<b>China RoHS</b>	✓
<b>cULus certificate</b>	✓
<b>IO-Link certificate</b>	✓
<b>Photobiological safety (IEC EN 62471)</b>	✓
<b>Information according to Art. 3 of Data Act (Regulation EU 2023/2854)</b>	✓

## Classifications

<b>ECLASS 5.0</b>	27270908
<b>ECLASS 5.1.4</b>	27270908
<b>ECLASS 6.0</b>	27270908
<b>ECLASS 6.2</b>	27270908
<b>ECLASS 7.0</b>	27270908
<b>ECLASS 8.0</b>	27270908
<b>ECLASS 8.1</b>	27270908
<b>ECLASS 9.0</b>	27270908
<b>ECLASS 10.0</b>	27270908
<b>ECLASS 11.0</b>	27270908
<b>ECLASS 12.0</b>	27270908
<b>ETIM 5.0</b>	EC001822
<b>ETIM 6.0</b>	EC001822
<b>ETIM 7.0</b>	EC001822
<b>ETIM 8.0</b>	EC001822
<b>UNSPSC 16.0901</b>	39121528

Dimensional drawing

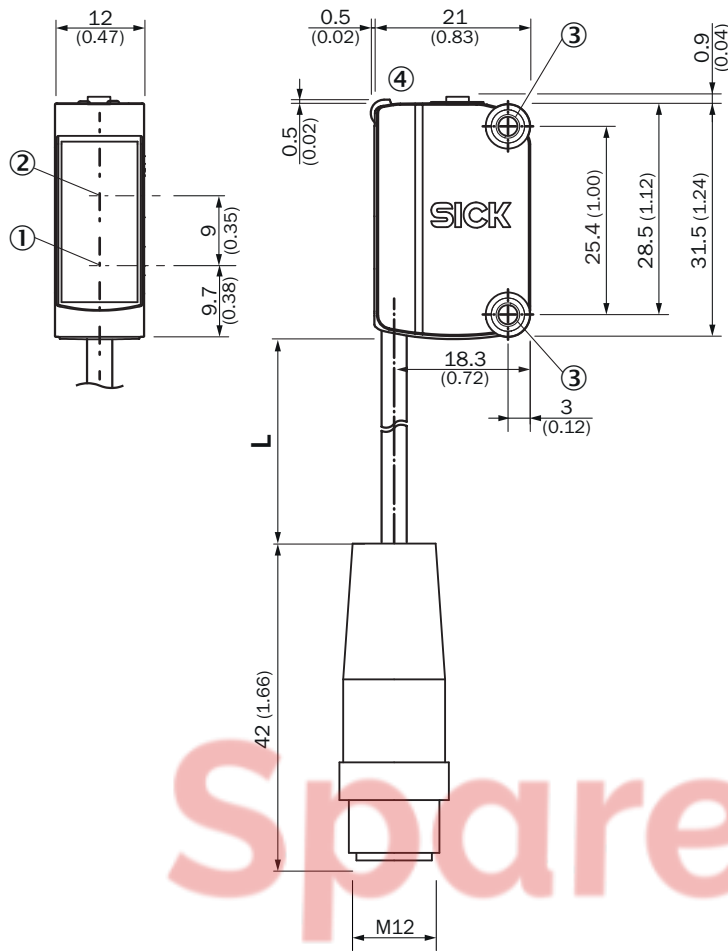

Dimensions in mm (inch)

For length of cable (L), see technical data

- ① Center of optical axis, sender
- ② Center of optical axis, receiver
- ③ Mounting holes M3
- ④ display and adjustment elements

display and adjustment elements

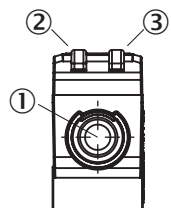

- ① Teach-in button
- ② LED yellow
- ③ LED green

Connection diagram Cd-309

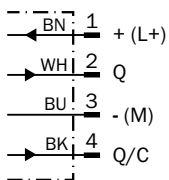

Setting the switching threshold (dynamic)

**1. Position background**

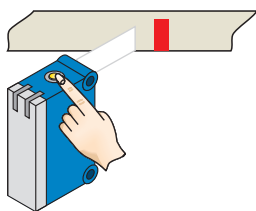

Press the teach-in button and keep it pressed. LED flashing slowly.

**2. Move at least the fluorescent mark and background using the light spot.**

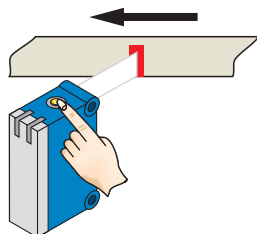

Keep the teach-in button > 3 < 30 s pressed.

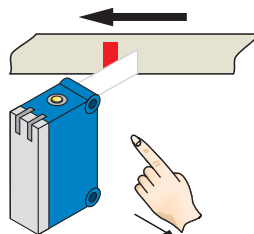

Release the teach-in button.

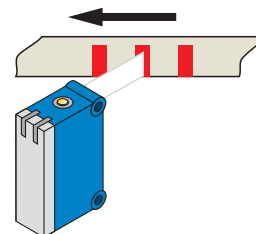

Yellow LED will illuminate, when emitted light is on the fluorescent mark.

**Sensitivity setting**

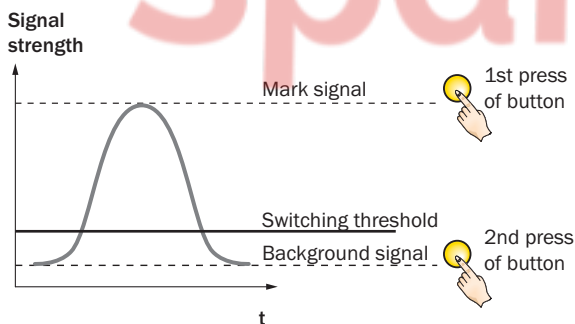

**Switching characteristics**

Static teach-in: light/dark setting is defined using teach-in sequence.

Dynamic teach-in: switching output active on fluorescent mark, if background is longer in the field of view during the teach-in. The switching threshold is set automatically between the background and the mark.

Teach-in can also be performed using an external control signal (only dynamic teach-in).

Keylock activation and deactivation: hold down teach-in button > 30 s.

Teach-in failure: yellow LED indicator and the transmitted light of the sensor flashing quickly.  
For dynamic teach-in with ET signal (5 Hz) via switching output Q.

### Setting the switching threshold (static)

#### 1. Position fluorescent mark

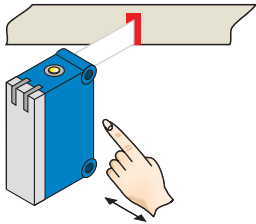

Press and hold teach-in button > 1 < 3 s.  
Yellow LED flashes slowly.

#### 2. Position background

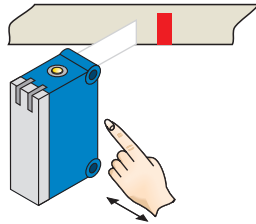

Press and hold teach-in button < 3 s.  
Yellow LED goes out.



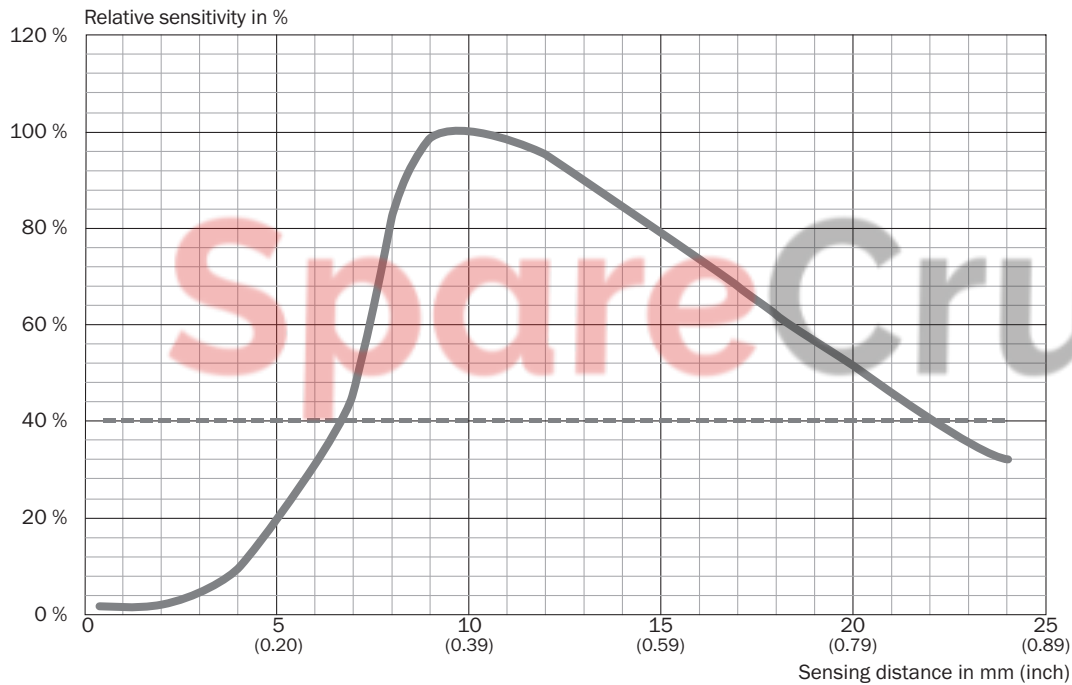

### Sensing distance

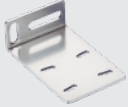

### Recommended accessories

Other models and accessories → [www.sick.com/LUTM](http://www.sick.com/LUTM)

	Brief description	Type	part no.
Mounting systems			
	<ul style="list-style-type: none"> <li>• <b>Material:</b> Stainless steel</li> <li>• <b>Details:</b> Stainless steel (1.4301)</li> <li>• <b>Suitable for:</b> W4S, W4S</li> </ul>	BEF-WN-G6	2062909

	Brief description	Type	part no.
network devices			
		IOLA2US-01101 (SiLink2 Master)	1061790
		SIG200-0A0412200	1089794
		SIG200-0A0G12200	1102605
connectors and cables			
 	<ul style="list-style-type: none"> <li>• <b>Connection type head A:</b> Male connector, M12, 4-pin, straight, A-coded</li> <li>• <b>Description:</b> Unshielded</li> <li>• <b>Connection systems:</b> Screw-type terminals</li> <li>• <b>Permitted cross-section:</b> <math>\leq 0.75 \text{ mm}^2</math></li> </ul> <ul style="list-style-type: none"> <li>• <b>Connection type head A:</b> Female connector, M12, 4-pin, straight, A-coded</li> <li>• <b>Connection type head B:</b> Flying leads</li> <li>• <b>Signal type:</b> Sensor/actuator cable</li> <li>• <b>Cable:</b> 5 m, 4-wire, PVC</li> <li>• <b>Description:</b> Sensor/actuator cable, unshielded</li> <li>• <b>Application:</b> Zones with chemicals, Uncontaminated zones</li> </ul>	STE-1204-G	6009932
		YF2A14-050VB3XLEAX	2096235

## SICK AT A GLANCE

SICK is one of the leading manufacturers of intelligent sensors and sensor solutions for industrial applications. A unique range of products and services creates the perfect basis for controlling processes securely and efficiently, protecting individuals from accidents and preventing damage to the environment.

We have extensive experience in a wide range of industries and understand their processes and requirements. With intelligent sensors, we can deliver exactly what our customers need. In application centers in Europe, Asia and North America, system solutions are tested and optimized in accordance with customer specifications. All this makes us a reliable supplier and development partner.

Comprehensive services complete our offering: SICK LifeTime Services provide support throughout the machine life cycle and ensure safety and productivity.

For us, that is “Sensor Intelligence.”

### WORLDWIDE PRESENCE:

Contacts and other locations – [www.sick.com](http://www.sick.com)

SpareCruX