



# GRTE18S-P2467

GR18

PHOTOELECTRIC SENSORS

**SICK**  
Sensor Intelligence.



Illustration may differ



### Ordering information

Type	part no.
GRTE18S-P2467	1069122

Other models and accessories → [www.sick.com/GR18](http://www.sick.com/GR18)

### Detailed technical data

#### Features

<b>Functional principle</b>	Photoelectric proximity sensor
<b>Functional principle detail</b>	Energetic
<b>Dimensions (W x H x D)</b>	18 mm x 18 mm x 38.1 mm
<b>Housing design (light emission)</b>	Cylindrical
<b>Thread diameter (housing)</b>	M18 x 1
<b>Optical axis</b>	Axial
<b>Sensing range max.</b>	5 mm ... 1,000 mm <sup>1)</sup>
<b>Sensing range</b>	10 mm ... 800 mm <sup>1)</sup>
<b>Type of light</b>	Visible red light
<b>Light source</b>	LED <sup>2)</sup>
<b>Light spot size (distance)</b>	Ø 45 mm (800 mm)
<b>Wave length</b>	650 nm
<b>Adjustment</b>	Potentiometer, 270°
<b>Display</b>	
	LED green
	Operating indicator Static on: power on
	LED yellow
	Status of received light beam Static on: object present Static off: object not present

<sup>1)</sup> Object with 90% remission (based on standard white, DIN 5033).

<sup>2)</sup> Average service life: 100,000 h at T<sub>U</sub> = +25 °C.

Mechanics/electronics

<b>Supply voltage <math>U_B</math></b>	10 V DC ... 30 V DC <sup>1)</sup>
<b>Ripple</b>	< 5 V <sub>pp</sub> <sup>2)</sup>
<b>Current consumption</b>	30 mA
<b>Switching output</b>	PNP
<b>Output function</b>	Complementary
<b>Switching mode</b>	Light/dark switching
<b>Output current <math>I_{max}</math></b>	≤ 100 mA <sup>3)</sup>
<b>Response time</b>	< 1,000 μs <sup>4)</sup>
<b>Switching frequency</b>	500 Hz <sup>5)</sup>
<b>Connection type</b>	Male connector M12, 4-pin
<b>Circuit protection</b>	A <sup>6)</sup> B <sup>7)</sup> D <sup>8)</sup>
<b>Protection class</b>	III
<b>Housing material</b>	Plastic, ABS
<b>Optics material</b>	Plastic, PMMA
<b>Enclosure rating</b>	IP67
<b>Items supplied</b>	Fastening nuts (2 x)
<b>Electromagnetic compatibility (EMC)</b>	EN 60947-5-2
<b>Ambient operating temperature</b>	-25 °C ... +55 °C <sup>9)</sup>
<b>Ambient temperature, storage</b>	-40 °C ... +70 °C
<b>UL File No.</b>	NRKH.E348498 & NRKH7.E348498

<sup>1)</sup> Limit values. Operated in short-circuit protected network: max. 8 A.

<sup>2)</sup> May not fall below or exceed  $U_V$  tolerances.

<sup>3)</sup> At  $U_V > 24$  V or ambient temperature > 49 °C,  $I_A$  max. = 50 mA.

<sup>4)</sup> Signal transit time with resistive load.

<sup>5)</sup> With light/dark ratio 1:1.

<sup>6)</sup> A =  $V_S$  connections reverse-polarity protected.

<sup>7)</sup> B = inputs and output reverse-polarity protected.

<sup>8)</sup> D = outputs overcurrent and short-circuit protected.

<sup>9)</sup> At  $U_V \leq 24$  V and  $I_A < 50$  mA.

Certificates

<b>EU declaration of conformity</b>	✓
<b>UK declaration of conformity</b>	✓
<b>ACMA declaration of conformity</b>	✓
<b>Moroccan declaration of conformity</b>	✓
<b>China RoHS</b>	✓
<b>ECOLAB certificate</b>	✓
<b>cULus certificate</b>	✓
<b>Photobiological safety (DIN EN 62471) certificate</b>	✓

### Classifications

<b>ECLASS 5.0</b>	27270903
<b>ECLASS 5.1.4</b>	27270903
<b>ECLASS 6.0</b>	27270903
<b>ECLASS 6.2</b>	27270903
<b>ECLASS 7.0</b>	27270903
<b>ECLASS 8.0</b>	27270903
<b>ECLASS 8.1</b>	27270903
<b>ECLASS 9.0</b>	27270903
<b>ECLASS 10.0</b>	27270904
<b>ECLASS 11.0</b>	27270904
<b>ECLASS 12.0</b>	27270903
<b>ETIM 5.0</b>	EC001821
<b>ETIM 6.0</b>	EC001821
<b>ETIM 7.0</b>	EC002719
<b>ETIM 8.0</b>	EC002719
<b>UNSPSC 16.0901</b>	39121528

Adjustments GRTB18(S), GRTE18(S), Sensing range setting: Potentiometer, 270°

Sensing range

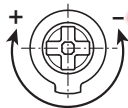

### Connection diagram Cd-084

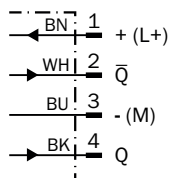

**Characteristic curve GRTE18, 800 mm**

Operating reserve

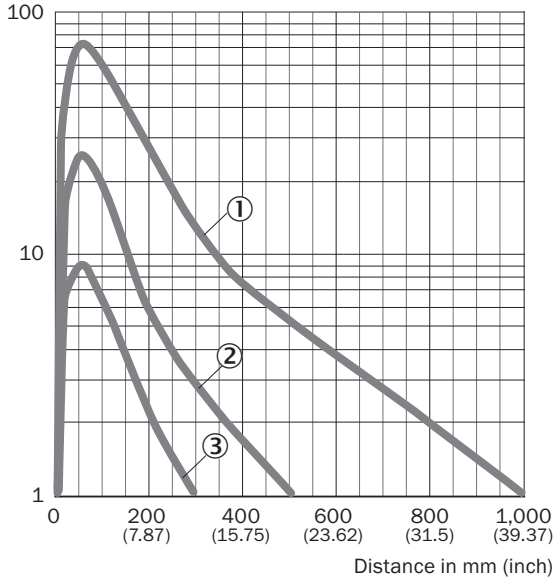

- ① Sensing range on black, 6% remission factor
- ② sensing range to gray, 20% remission factor
- ③ Sensing range on white, 90% remission factor



**Light spot size GRTE18, 800 mm**

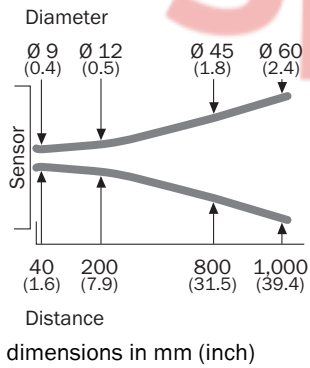

**Sensing range diagram GRTE18, 800 mm**

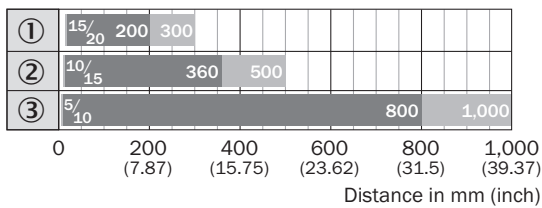

■ Sensing range      ■ Sensing range max. typ.

- ① Sensing range on black, 6% remission factor
- ② sensing range to gray, 20% remission factor
- ③ Sensing range on white, 90% remission factor

Response range GRTE18, 800 mm

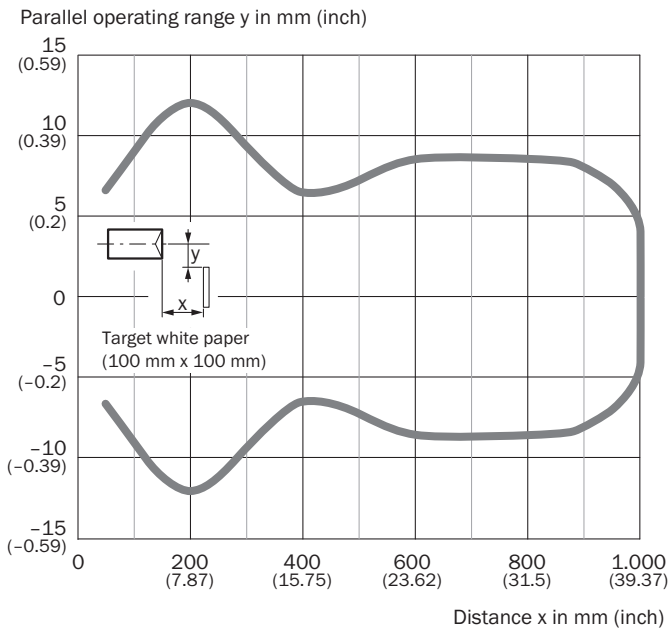

Dimensional drawing GR18S, plastic, connector, straight, adjustable

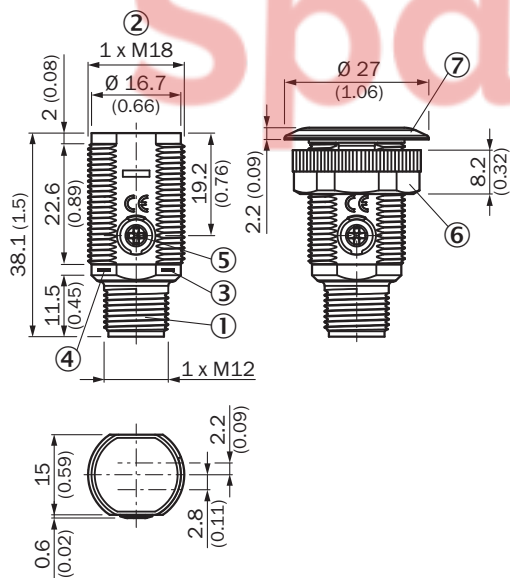





Dimensions in mm (inch)

- ① Connector M12, 3-pin
- ② Threaded mounting hole M18 x 1
- ③ LED indicator yellow
- ④ LED indicator green
- ⑤ sensitivity control: potentiometer 270°
- ⑥ fastening nut; 22 mm hex, plastic
- ⑦ Mounting ring

## Recommended accessories

Other models and accessories → [www.sick.com/GR18](http://www.sick.com/GR18)

	Brief description	Type	part no.
Mounting systems			
	<ul style="list-style-type: none"> <li><b>Description:</b> Mounting bracket for M18 sensors</li> <li><b>Material:</b> Steel</li> <li><b>Details:</b> Steel, zinc coated</li> <li><b>Items supplied:</b> Without mounting hardware</li> <li><b>Suitable for:</b> GR18, V180-2, V18, W15, Z1, Z2</li> </ul>	BEF-WN-M18	5308446
connectors and cables			
	<ul style="list-style-type: none"> <li><b>Connection type head A:</b> Female connector, M12, 4-pin, straight, A-coded</li> <li><b>Connection type head B:</b> Flying leads</li> <li><b>Signal type:</b> Sensor/actuator cable</li> <li><b>Cable:</b> 5 m, 4-wire, PVC</li> <li><b>Description:</b> Sensor/actuator cable, unshielded</li> <li><b>Application:</b> Zones with chemicals, Uncontaminated zones</li> </ul>	YF2A14-050VB3XLEAX	2096235
	<ul style="list-style-type: none"> <li><b>Connection type head A:</b> Male connector, M12, 4-pin, straight, A-coded</li> <li><b>Description:</b> Unshielded</li> <li><b>Connection systems:</b> Screw-type terminals</li> <li><b>Permitted cross-section:</b> ≤ 0.75 mm<sup>2</sup></li> </ul>	STE-1204-G	6009932
	<ul style="list-style-type: none"> <li><b>Connection type head A:</b> Female connector, M12, 4-pin, straight, A-coded</li> <li><b>Connection type head B:</b> Flying leads</li> <li><b>Signal type:</b> Sensor/actuator cable</li> <li><b>Cable:</b> 5 m, 4-wire, PUR, halogen-free</li> <li><b>Description:</b> Sensor/actuator cable, unshielded</li> <li><b>Application:</b> Uncontaminated zones, Zones with oils and lubricants, Robot, Drag chain operation</li> </ul>	YF2A14-050UB3XLEAX	2095608

SpareCruX

## SICK AT A GLANCE

SICK is one of the leading manufacturers of intelligent sensors and sensor solutions for industrial applications. A unique range of products and services creates the perfect basis for controlling processes securely and efficiently, protecting individuals from accidents and preventing damage to the environment.

We have extensive experience in a wide range of industries and understand their processes and requirements. With intelligent sensors, we can deliver exactly what our customers need. In application centers in Europe, Asia and North America, system solutions are tested and optimized in accordance with customer specifications. All this makes us a reliable supplier and development partner.

Comprehensive services complete our offering: SICK LifeTime Services provide support throughout the machine life cycle and ensure safety and productivity.

For us, that is “Sensor Intelligence.”

### WORLDWIDE PRESENCE:

Contacts and other locations – [www.sick.com](http://www.sick.com)

SpareCruX