

MZT7-03VPO-KP0

MZT7

CYLINDER SENSORS

SICK
Sensor Intelligence.

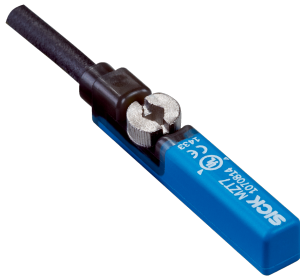

Ordering information

Type	part no.
MZT7-03VPO-KPO	1070818

Other models and accessories → www.sick.com/MZT7

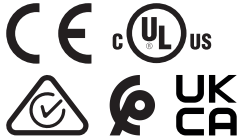

Detailed technical data

Features

Cylinder type	T-slot
Cylinder types with adapter	Profile cylinder Tie rod cylinder Round body cylinder Dovetail groove cylinder SMC rail CDQ2 SMC rail ECDQ2
Housing length	29.5 mm
Switching output	PNP
Switching frequency	1,000 Hz
Output function	NC
Electrical wiring	DC 3-wire
Enclosure rating	IP65 ¹⁾ IP67

¹⁾ According to EN 60529.

Mechanics/electronics

Supply voltage	10 V DC ... 30 V DC
Power consumption	8 mA, without load
Voltage drop	≤ 2 V
Continuous current I_a	≤ 100 mA
Protection class	III
Response sensitivity, typ.	3 mT
Overrun distance, typ.	10 mm ¹⁾
Hysteresis, typ.	< 0.8 mT
Reproducibility	≤ 0.1 mT ²⁾
Reverse polarity protection	Yes

¹⁾ Distance covered by the encoder magnet while the sensor outputs a switching signal.

²⁾ Supply voltage U_B and constant ambient temperature T_a.

Short-circuit protection	Yes
Status indicator LED	Yes
Teach-in	No
Ambient operating temperature	-30 °C ... +80 °C
Shock and vibration resistance	30 g, 11 ms / 10 ... 55 Hz, 1 mm
EMC	According to EN 60947-5-2
Connection type	Cable with connector M8, 3-pin, drag chain use, 0.3 m
Connection type Detail	
Conductor cross section	0.14 mm ²
Cable diameter	Ø 2.9 mm
Bending radius	With fixed installation > 8 x cable diameter For flexible use > 12 x cable diameter
Cable outlet	Axial
Material	
Housing	Plastic
Cable	PUR
UL File No.	NRKH.E181493 & NRKH7.E181493

¹⁾ Distance covered by the encoder magnet while the sensor outputs a switching signal.

²⁾ Supply voltage U_B and constant ambient temperature T_a .

Safety-related parameters

MTTF_D	1,300 years
DC_{avg}	0 %
T_M (mission time)	20 years

Classifications

ECLASS 5.0	27270104
ECLASS 5.1.4	27270104
ECLASS 6.0	27270104
ECLASS 6.2	27270104
ECLASS 7.0	27270104
ECLASS 8.0	27270104
ECLASS 8.1	27270104
ECLASS 9.0	27270104
ECLASS 10.0	27270104
ECLASS 11.0	27270104
ECLASS 12.0	27274301
ETIM 5.0	EC002544
ETIM 6.0	EC002544
ETIM 7.0	EC002544
ETIM 8.0	EC002544
UNSPSC 16.0901	39122230

Certificates

EU declaration of conformity	✓
UK declaration of conformity	✓
ACMA declaration of conformity	✓
Moroccan declaration of conformity	✓
China RoHS	✓
cULus certificate	✓

Installation note

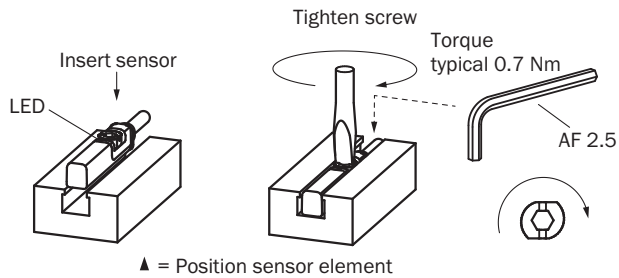

Connection diagram Cd-004

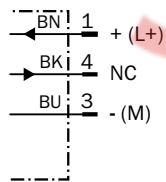

Functional principle Overrun distance

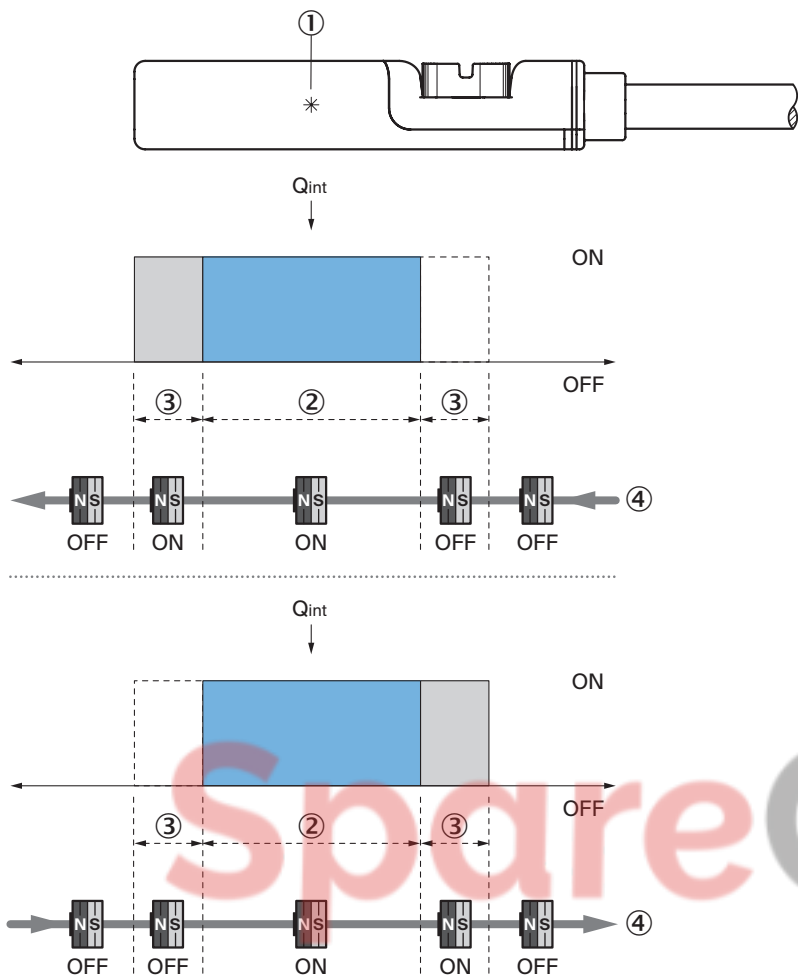

Note: Sensor housing may differ; representation corresponds to "NO contact" output function; overrun distance = switching point width + hysteresis

- ① Position sensor element
- ② Width of the switching point
- ③ Hysteresis
- ④ Direction of movement of the magnet

Dimensional drawing Cable with connector M8

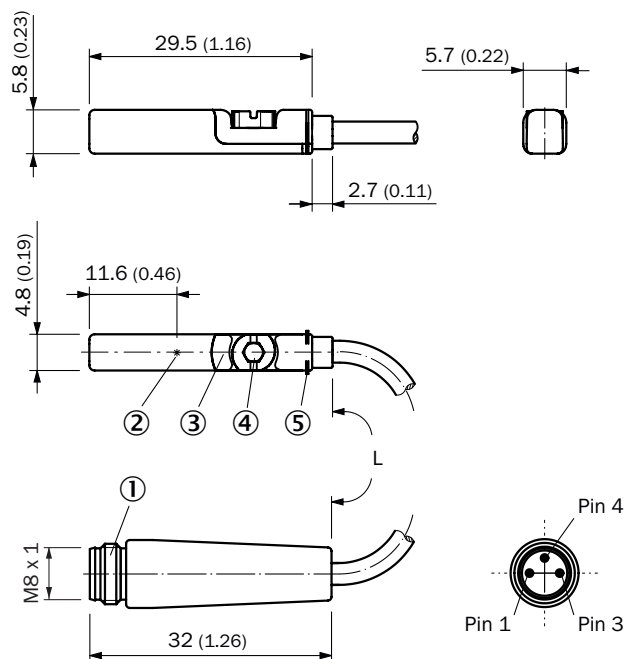

Dimensions in mm (inch)

- ① Connection
- ② Position sensor element
- ③ Display LED
- ④ Fixing screw SW 2.5
- ⑤ retaining ribs

Part no.	Type	L	Number of cores
1104369	MZT7-03VPS-KPD	250 mm	3
1070814	MZT7-03VPS-KPO	300 mm	3
1070818	MZT7-03VPO-KPO	300 mm	3
1070819	MZT7-03VNS-KPO	300 mm	3
1070820	MZT7-03VNO-KPO	300 mm	3



Recommended accessories

Other models and accessories → www.sick.com/MZT7

	Brief description	Type	part no.
Mounting systems			
	<ul style="list-style-type: none"> Description: Mounting bracket on round body cylinder with piston diameter of 8 mm ... 130 mm, ambient temperature min -30 °C max 80 °C Material: Stainless steel, Zinc cast Details: Stainless steel, Zinc cast Packing unit: 1 piece Suitable for: T-slot 	BEF-KHZ-RT1-130	2077684
	<ul style="list-style-type: none"> Description: Mounting bracket on round body cylinder with piston diameter of 8 mm ... 25 mm, ambient temperature min -30 °C max 80 °C Material: Stainless steel, Zinc cast Details: Stainless steel, Zinc cast Packing unit: 1 piece Suitable for: T-slot 	BEF-KHZ-RT1-25	2077682
	<ul style="list-style-type: none"> Description: Mounting bracket on round body cylinder with piston diameter of 8 mm ... 63 mm, ambient temperature min -30 °C max 80 °C Material: Stainless steel, Zinc cast Details: Stainless steel, Zinc cast Packing unit: 1 piece Suitable for: T-slot 	BEF-KHZ-RT1-63	2077683
	<ul style="list-style-type: none"> Description: Mounting bracket on round body cylinder with piston diameter of 12 mm, ambient temperature min 0 °C max 50 °C Dimensions (W x H x L): 22.4 m Material: Plastic, Aluminum Details: Plastic, Aluminum Packing unit: 1 piece Suitable for: T-slot 	BEF-KHZ-RT-12	2077681
	<ul style="list-style-type: none"> Description: Mounting bracket on round body cylinder with piston diameter of 16 mm, ambient temperature min 0 °C max 50 °C Dimensions (W x H x L): 26.6 m Material: Plastic, Aluminum Details: Plastic, Aluminum Packing unit: 1 piece Suitable for: T-slot 	BEF-KHZ-RT-16	2077680
	<ul style="list-style-type: none"> Description: Mounting bracket on round body cylinder with piston diameter of 20 mm, ambient temperature min 0 °C max 50 °C Dimensions (W x H x L): 30.6 m Material: Plastic, Aluminum Details: Plastic, Aluminum Packing unit: 1 piece Suitable for: T-slot 	BEF-KHZ-RT-20	2077679
	<ul style="list-style-type: none"> Description: Mounting bracket on round body cylinder with piston diameter of 25 mm, ambient temperature min 0 °C max 50 °C Dimensions (W x H x L): 35.7 m Material: Plastic, Aluminum Details: Plastic, Aluminum Packing unit: 1 piece Suitable for: T-slot 	BEF-KHZ-RT-25	2077678
	<ul style="list-style-type: none"> Description: Mounting bracket on round body cylinder with piston diameter of 32 mm, ambient temperature min 0 °C max 50 °C Dimensions (W x H x L): 42.9 m Material: Plastic, Aluminum Details: Plastic, Aluminum Packing unit: 1 piece Suitable for: T-slot 	BEF-KHZ-RT-32	2077677
	<ul style="list-style-type: none"> Description: Mounting bracket on round body cylinder with piston diameter of 40 mm, ambient temperature min 0 °C max 50 °C Dimensions (W x H x L): 50.9 m Material: Plastic, Aluminum Details: Plastic, Aluminum Packing unit: 1 piece 	BEF-KHZ-RT-40	2077676

	Brief description	Type	part no.
	<ul style="list-style-type: none"> • Suitable for: T-slot • Description: Mounting bracket on round body cylinder with piston diameter of 50 mm, ambient temperature min 0 °C max 50 °C • Dimensions (W x H x L): 61.8 mm • Material: Plastic, Aluminum • Details: Plastic, Aluminum • Packing unit: 1 piece • Suitable for: T-slot 	BEF-KHZ-RT-50	2077675
	<ul style="list-style-type: none"> • Description: Mounting bracket on round body cylinder with piston diameter of 63 mm, ambient temperature min 0 °C max 50 °C • Dimensions (W x H x L): 73.9 mm • Material: Plastic, Aluminum • Details: Plastic, Aluminum • Packing unit: 1 piece • Suitable for: T-slot 	BEF-KHZ-RT-63	2077674
	<ul style="list-style-type: none"> • Description: Mounting bracket for integrated profile cylinder/tie-rod cylinder • Material: Zinc diecast • Details: Zinc diecast • Items supplied: Mounting hardware included 	BEF-KHZ-PT1	2022702
	<ul style="list-style-type: none"> • Description: Mounting bracket for mounting on SMC rails ECDQ2 (T-slot) • Material: Aluminum • Details: Aluminum • Items supplied: Without mounting hardware 	BEF-KHZ-TT1	2046439
	<ul style="list-style-type: none"> • Description: Mounting bracket for mounting on SMC rails CDQ2 (T-slot) • Material: Aluminum • Details: Aluminum • Items supplied: Without mounting hardware 	BEF-KHZ-TT2	2046440
	<ul style="list-style-type: none"> • Description: Mounting bracket for cylinder with dovetail slot • Material: Aluminum • Details: Aluminum • Items supplied: Without mounting hardware 	BEF-KHZ-ST1	2022703
	<p>device protection and care</p> <ul style="list-style-type: none"> • Description: Protective adapter • Material: Zinc diecast • Items supplied: Mounting hardware included • Suitable for: MZT7, RZT7, MZT8 	BEF-SG-MRZT	2077201

	Brief description	Type	part no.
connectors and cables			
	<ul style="list-style-type: none"> • Connection type head A: Male connector, M8, 3-pin, straight, A-coded • Description: Unshielded • Connection systems: Screw-type terminals • Permitted cross-section: 0.14 mm² ... 0.5 mm² 	STE-0803-G	6037322
	<ul style="list-style-type: none"> • Connection type head A: Female connector, M8, 3-pin, straight, A-coded • Description: Unshielded • Connection systems: Screw-type terminals • Permitted cross-section: 0.14 mm² ... 0.5 mm² 	DOS-0803-G	7902077
	<ul style="list-style-type: none"> • Connection type head A: Female connector, M8, 3-pin, angled, A-coded • Description: Unshielded • Connection systems: Solder connection • Permitted cross-section: ≤ 0.25 mm² 	DOS-0803-W	7902078
	<ul style="list-style-type: none"> • Connection type head A: Female connector, M8, 3-pin, straight, A-coded • Connection type head B: Flying leads • Signal type: Sensor/actuator cable • Cable: 2 m, 3-wire, PVC • Description: Sensor/actuator cable, unshielded • Application: Zones with chemicals, Uncontaminated zones 	YF8U13-020VA1XLEAX	2095860
	<ul style="list-style-type: none"> • Connection type head A: Female connector, M8, 3-pin, straight, A-coded • Connection type head B: Flying leads • Signal type: Sensor/actuator cable • Cable: 5 m, 3-wire, PVC • Description: Sensor/actuator cable, unshielded • Application: Zones with chemicals, Uncontaminated zones 	YF8U13-050VA1XLEAX	2095884
	<ul style="list-style-type: none"> • Connection type head A: Female connector, M8, 3-pin, angled, A-coded • Connection type head B: Flying leads • Signal type: Sensor/actuator cable • Cable: 2 m, 3-wire, PVC • Description: Sensor/actuator cable, unshielded • Application: Zones with chemicals, Uncontaminated zones 	YG8U13-020VA1XLEAX	2096165
	<ul style="list-style-type: none"> • Connection type head A: Female connector, M8, 3-pin, angled, A-coded • Connection type head B: Flying leads • Signal type: Sensor/actuator cable • Cable: 5 m, 3-wire, PVC • Description: Sensor/actuator cable, unshielded • Application: Zones with chemicals, Uncontaminated zones 	YG8U13-050VA1XLEAX	2096166
	<ul style="list-style-type: none"> • Connection type head A: Female connector, M8, 3-pin, straight, A-coded • Connection type head B: Flying leads • Signal type: Sensor/actuator cable • Cable: 2 m, 3-wire, PUR, halogen-free • Description: Sensor/actuator cable, unshielded • Application: Uncontaminated zones, Zones with oils and lubricants, Robot, Drag chain operation 	YF8U13-020UA1XLEAX	2094782
	<ul style="list-style-type: none"> • Connection type head A: Female connector, M8, 3-pin, straight, A-coded • Connection type head B: Flying leads • Signal type: Sensor/actuator cable • Cable: 5 m, 3-wire, PUR, halogen-free • Description: Sensor/actuator cable, unshielded • Application: Uncontaminated zones, Zones with oils and lubricants, Robot, Drag chain operation 	YF8U13-050UA1XLEAX	2094788
	<ul style="list-style-type: none"> • Connection type head A: Female connector, M8, 3-pin, angled, A-coded • Connection type head B: Flying leads • Signal type: Sensor/actuator cable • Cable: 2 m, 3-wire, PUR, halogen-free • Description: Sensor/actuator cable, unshielded • Application: Uncontaminated zones, Zones with oils and lubricants, Robot, Drag chain operation 	YG8U13-020UA1XLEAX	2094794
	<ul style="list-style-type: none"> • Connection type head A: Female connector, M8, 3-pin, straight, A-coded • Connection type head B: Flying leads • Signal type: Sensor/actuator cable • Cable: 3 m, 3-wire, PUR, halogen-free • Description: Sensor/actuator cable, unshielded 	YF8U13-030UA1XLEAX	2094787

	Brief description	Type	part no.
	<ul style="list-style-type: none"> • Application: Uncontaminated zones, Zones with oils and lubricants, Robot, Drag chain operation • Connection type head A: Female connector, M8, 3-pin, angled, A-coded • Connection type head B: Flying leads • Signal type: Sensor/actuator cable • Cable: 0.6 m, 3-wire, PUR, halogen-free • Description: Sensor/actuator cable, unshielded • Application: Uncontaminated zones, Zones with oils and lubricants, Robot, Drag chain operation 	YG8U13-C60UA1XLEAX	2145889
	<ul style="list-style-type: none"> • Connection type head A: Female connector, M8, 3-pin, angled, A-coded • Connection type head B: Flying leads • Signal type: Sensor/actuator cable • Cable: 3 m, 3-wire, PUR, halogen-free • Description: Sensor/actuator cable, unshielded • Application: Uncontaminated zones, Zones with oils and lubricants, Robot, Drag chain operation 	YG8U13-030UA1XLEAX	2145891
	<ul style="list-style-type: none"> • Connection type head A: Female connector, M8, 3-pin, straight, A-coded • Connection type head B: Flying leads • Signal type: Sensor/actuator cable • Cable: 0.6 m, 3-wire, PVC • Description: Sensor/actuator cable, unshielded • Application: Zones with chemicals, Uncontaminated zones 	YF8U13-C60VA1XLEAX	2146368



SICK AT A GLANCE

SICK is one of the leading manufacturers of intelligent sensors and sensor solutions for industrial applications. A unique range of products and services creates the perfect basis for controlling processes securely and efficiently, protecting individuals from accidents and preventing damage to the environment.

We have extensive experience in a wide range of industries and understand their processes and requirements. With intelligent sensors, we can deliver exactly what our customers need. In application centers in Europe, Asia and North America, system solutions are tested and optimized in accordance with customer specifications. All this makes us a reliable supplier and development partner.

Comprehensive services complete our offering: SICK LifeTime Services provide support throughout the machine life cycle and ensure safety and productivity.

For us, that is “Sensor Intelligence.”

WORLDWIDE PRESENCE:

Contacts and other locations – www.sick.com

SpareCruX