



MM18-00APS-ZCK

MME

MAGNETIC SENSORS

SICK
Sensor Intelligence.



Ordering information

Type	part no.
MM18-00APS-ZCK	1076085

Included in delivery: BEF-MU-M18 (1)

Other models and accessories → www.sick.com/MME



Detailed technical data

Features

Housing	Metric
Housing	Short-body
Thread size	M18 x 1
Diameter	Ø 18 mm
Sensing range S_n	5 mm ... 120 mm 1) 2) 3)
Safe sensing range S_a	97.2 mm ²⁾ 3) 2) 3)
Magnetic sensitivity	0.4 mT
Switching frequency	5,000 Hz
Connection type	Male connector M12, 4-pin
Switching output	PNP
Switching output detail	PNP
Output function	NO
Electrical wiring	DC 3-wire
Enclosure rating	IP67 ⁴⁾
Items supplied	Mounting nut, brass, nickel-plated (2x)

¹⁾ Max. flux density allowed at the sensor: 280mT.

²⁾ Excluding the geomagnetic field.

³⁾ Based on M4.0 magnet.

⁴⁾ According to EN 60529.

Mechanics/electronics

Supply voltage	10 V DC ... 30 V DC
Ripple	≤ 10 %
Voltage drop	≤ 2 V ¹⁾
Current consumption	10 mA ²⁾
Time delay before availability	≤ 100 ms
Hysteresis	10 % ... 20 %
Reproducibility	≤ 1 % ³⁾ 4)
Temperature drift (of S_r)	± 10 %
EMC	According to EN 60947-5-2
Continuous current I_a	≤ 200 mA
Reverse polarity protection	Yes
Short-circuit protection	Yes ⁵⁾
Power-up pulse protection	✓
Shock and vibration resistance	30 g, 11 ms/10 Hz ... 55 Hz, 1 mm
Ambient operating temperature	-40 °C ... +75 °C
Housing material	Metal, Nickel-plated brass
Sensing face material	Plastic
Housing length	58 mm
Thread length	42 mm
Tightening torque, max.	≤ 40 Nm
Protection class	III

¹⁾ At I_a max.

²⁾ Without load.

³⁾ Supply voltage U_B and constant ambient temperature T_a.

⁴⁾ Of S_r.

⁵⁾ Pulsed.

Safety-related parameters

MTTF_D	2,238 years
DC_{avg}	0%
T_M (mission time)	20 years

Certificates

EU declaration of conformity	✓
UK declaration of conformity	✓
ACMA declaration of conformity	✓
Moroccan declaration of conformity	✓
China RoHS	✓

Classifications

ECLASS 5.0	27270104
ECLASS 5.1.4	27270104

ECLASS 6.0	27270104
ECLASS 6.2	27270104
ECLASS 7.0	27270104
ECLASS 8.0	27270104
ECLASS 8.1	27270104
ECLASS 9.0	27270104
ECLASS 10.0	27270104
ECLASS 11.0	27270104
ECLASS 12.0	27274301
ETIM 5.0	EC002544
ETIM 6.0	EC002544
ETIM 7.0	EC002544
ETIM 8.0	EC002544
UNSPSC 16.0901	39122230

Installation note

installation in magnetizable material

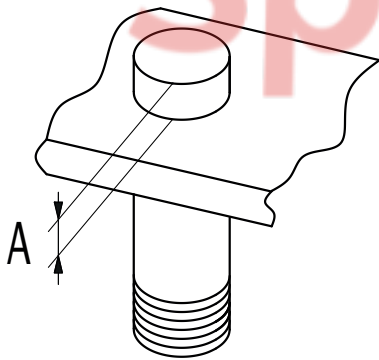

installation in non-magnetizable material

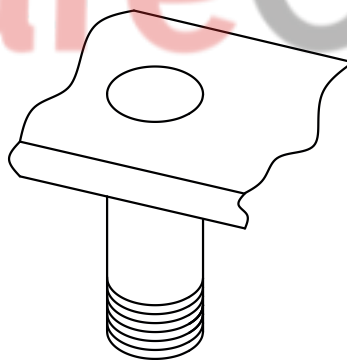

Ø	A (mm)	M (Nm)
M18	20	< 40

Connection diagram Cd-007

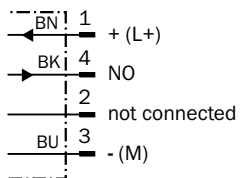

Sensing range

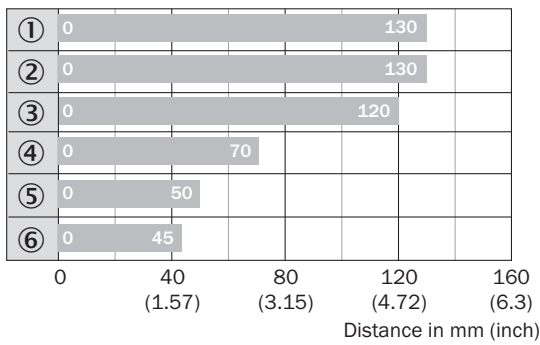

■ Max. sensing range S_n, flush or non-flush installation, non-magnetizable material

Magnet type	Part no.
① MAG-3315-B (M 5.1)	7902086
② MAG-3015-B (M 5.0)	7901786
③ MAG-3010-B (M 4.0)	7901785
④ MAG-2006-B (M 3.0)	7901784
⑤ MAG-0625-A (M 2.0)	7901783
⑥ MAG-1003-S (M 1.0)	7901782

Dimensional drawing MM18 Namur, connector

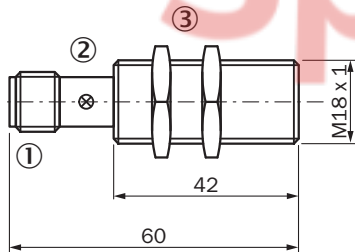





Dimensions in mm (inch)

- ① Connection
- ② Display LED
- ③ Fastening nuts (2x); width across 24, metal

Recommended accessories

Other models and accessories → www.sick.com/MME

	Brief description	Type	part no.
Mounting systems			
	<ul style="list-style-type: none"> Description: Clamping block for round sensors M18, without fixed stop Material: Plastic Details: Plastic (PA12), glass-fiber reinforced Items supplied: Mounting hardware included Suitable for: GR18, MH15V, V180-2, V18 	BEF-KH-M18	2051481
	<ul style="list-style-type: none"> Description: Clamping block for round sensors M18, with fixed stop Material: Plastic Details: Plastic (PA12), glass-fiber reinforced Items supplied: Mounting hardware included Suitable for: GR18, MH15V, V180-2, V18 	BEF-KHF-M18	2051482
	<ul style="list-style-type: none"> Description: Mounting bracket for M18 sensors Material: Steel Details: Steel, zinc coated Items supplied: Without mounting hardware Suitable for: GR18, V180-2, V18, W15, Z1, Z2 	BEF-WN-M18	5308446
	<ul style="list-style-type: none"> Description: Mounting plate for M18 sensors Material: Steel Details: Steel, zinc coated Items supplied: Without mounting hardware Suitable for: GR18, V180-2, V18, W15, Z1, Z2 	BEF-WG-M18	5321870

SpareCruX

	Brief description	Type	part no.
connectors and cables			
	<ul style="list-style-type: none"> Connection type head A: Male connector, M12, 4-pin, angled, A-coded Description: Unshielded Connection systems: Screw-type terminals Permitted cross-section: $\leq 0.75 \text{ mm}^2$ 	STE-1204-W	6022084
	<ul style="list-style-type: none"> Connection type head A: Female connector, M12, 4-pin, straight, A-coded Description: Unshielded Connection systems: Screw-type terminals Permitted cross-section: $\leq 0.75 \text{ mm}^2$ 	DOS-1204-G	6007302
	<ul style="list-style-type: none"> Connection type head A: Female connector, M12, 4-pin, angled, A-coded Description: Unshielded Connection systems: Screw-type terminals Permitted cross-section: $\leq 0.75 \text{ mm}^2$ 	DOS-1204-W	6007303
	<ul style="list-style-type: none"> Connection type head A: Male connector, M12, 4-pin, straight, A-coded Description: Unshielded Connection systems: Screw-type terminals Permitted cross-section: $\leq 0.75 \text{ mm}^2$ 	STE-1204-G	6009932
	<ul style="list-style-type: none"> Connection type head A: Female connector, M12, 4-pin, straight, A-coded Connection type head B: Flying leads Signal type: Sensor/actuator cable Cable: 2 m, 4-wire, PVC Description: Sensor/actuator cable, unshielded Application: Zones with chemicals, Uncontaminated zones 	YF2A14-020VB3XLEAX	2096234
	<ul style="list-style-type: none"> Connection type head A: Female connector, M12, 4-pin, straight, A-coded Connection type head B: Flying leads Signal type: Sensor/actuator cable Cable: 5 m, 4-wire, PVC Description: Sensor/actuator cable, unshielded Application: Zones with chemicals, Uncontaminated zones 	YF2A14-050VB3XLEAX	2096235
	<ul style="list-style-type: none"> Connection type head A: Female connector, M12, 4-pin, angled, A-coded Connection type head B: Flying leads Signal type: Sensor/actuator cable Cable: 2 m, 4-wire, PVC Description: Sensor/actuator cable, unshielded Application: Zones with chemicals, Uncontaminated zones 	YG2A14-020VB3XLEAX	2095895
	<ul style="list-style-type: none"> Connection type head A: Female connector, M12, 4-pin, angled, A-coded Connection type head B: Flying leads Signal type: Sensor/actuator cable Cable: 5 m, 4-wire, PVC Description: Sensor/actuator cable, unshielded Application: Zones with chemicals, Uncontaminated zones 	YG2A14-050VB3XLEAX	2095897
	<ul style="list-style-type: none"> Connection type head A: Female connector, M12, 4-pin, angled, A-coded Connection type head B: Flying leads Signal type: Sensor/actuator cable Cable: 0.6 m, 4-wire, PVC Description: Sensor/actuator cable, unshielded Application: Zones with chemicals, Uncontaminated zones 	YG2A14-C60VB3XLEAX	2145709
	<ul style="list-style-type: none"> Connection type head A: Female connector, M12, 4-pin, angled, A-coded Connection type head B: Flying leads Signal type: Sensor/actuator cable Cable: 1 m, 4-wire, PVC Description: Sensor/actuator cable, unshielded Application: Zones with chemicals, Uncontaminated zones 	YG2A14-010VB3XLEAX	2145710
	<ul style="list-style-type: none"> Connection type head A: Female connector, M12, 4-pin, straight, A-coded Connection type head B: Flying leads Signal type: Sensor/actuator cable Cable: 0.6 m, 4-wire, PVC Description: Sensor/actuator cable, unshielded Application: Zones with chemicals, Uncontaminated zones 	YF2A14-C60VB3XLEAX	2145707
	<ul style="list-style-type: none"> Connection type head A: Female connector, M12, 4-pin, straight, A-coded Connection type head B: Flying leads Signal type: Sensor/actuator cable Cable: 1 m, 4-wire, PVC Description: Sensor/actuator cable, unshielded Application: Zones with chemicals, Uncontaminated zones 	YF2A14-010VB3XLEAX	2145708

SICK AT A GLANCE

SICK is one of the leading manufacturers of intelligent sensors and sensor solutions for industrial applications. A unique range of products and services creates the perfect basis for controlling processes securely and efficiently, protecting individuals from accidents and preventing damage to the environment.

We have extensive experience in a wide range of industries and understand their processes and requirements. With intelligent sensors, we can deliver exactly what our customers need. In application centers in Europe, Asia and North America, system solutions are tested and optimized in accordance with customer specifications. All this makes us a reliable supplier and development partner.

Comprehensive services complete our offering: SICK LifeTime Services provide support throughout the machine life cycle and ensure safety and productivity.

For us, that is “Sensor Intelligence.”

WORLDWIDE PRESENCE:

Contacts and other locations – www.sick.com

SpareCruX