



MPS-200CLTPO

MPS-C

CYLINDER SENSORS

SICK
Sensor Intelligence.



Ordering information

Type	part no.
MPS-200CLTP0	1079364

Other models and accessories → www.sick.com/MPS-C



Detailed technical data

Features

Cylinder type	C-slot
Cylinder types with adapter	Round body cylinder Profile cylinders and tie-rod cylinders SMC rail CDQ2 SMC rail ECDQ2
Measuring range	200 mm ¹⁾
Housing length	215 mm
Switching output	Push-pull: PNP/NPN
Output function	Analog, IO-Link
Electrical wiring	DC 4-wire
Analog output (voltage)	0 V ... 10 V
Analog output (current)	4 mA ... 20 mA
Enclosure rating	IP67 ²⁾
Adjustment	
Teach-in control panel	Teaching in analog outputs Selecting the current/voltage output Inverting the analog output Teaching in digital switching outputs
IO-Link	Teaching in 4 switching points Pin 2 configuration (0 V–10 V, 4 mA–20 mA) Measuring range (mm) teach-in (analog output) Disabling teach-in pushbutton Teach-in modes per output via IO-Link (cylinder switch mode, two point mode, window mode, and single point mode)

¹⁾ ± 1 mm.

²⁾ According to EN 60529.

Mechanics/electronics

Supply voltage	12 V DC ... 30 V DC
Power consumption	42 mA, without load
Voltage drop	≤ 2 V
Continuous current I_a	≤ 100 mA ¹⁾
Max. load resistance	≤ 500 Ω Power Output, at 24 V
Min. load resistance	≥ 2 kΩ ²⁾
Protection class	III
Time delay before availability	0.15 s
Required magnetic field sensitivity, typ.	3 mT ... 12 mT
Resolution, typ.	≥ 50 μm
Linearity error, typ.	0.3 mm ³⁾
Repeat accuracy, typ.	0.1 mm ⁴⁾
Sampling rate, typ.	1 ms
Reverse polarity protection	Yes
Short-circuit protection	Yes
Status indicator LED	Yes
Digital switching output	Yes
Teach-in	Yes
Ambient operating temperature	-20 °C ... +70 °C
Shock and vibration resistance	30 g, 11 ms / 10 ... 55 Hz, 1 mm
EMC	According to EN 60947-5-7 ⁵⁾
Connection type	Cable with M8 male connector, 4-pin, 0.3 m
Connection type Detail	
Deep-freeze property	Do not bend below 0 °C
Conductor cross section	0.08 mm ²
Cable diameter	Ø 2.6 mm
Bending radius	With fixed installation > 5 x cable diameter For flexible use > 10 x cable diameter
Cable outlet	Axial
Material	
Housing	Plastic
Cable	PUR
UL File No.	NRKH.E181493 & NRKH7.E181493

¹⁾ ≤ 100 mA (PUSH); ≥ -100 mA (PULL).

²⁾ Voltage output.

³⁾ At 25 °C, linearity error (maximum deviation) depending on response curve and minimal deviation function.

⁴⁾ At 25 °C, repeatability magnet movement in one direction.

⁵⁾ The analog measured value can deviate under transient conditions.

Safety-related parameters

MTTF_D	72 years
DC_{avg}	0 %

T_M (mission time)	20 years
-------------------------------------	----------

Communication interface

Communication interface	IO-Link V1.1
Communication Interface detail	COM3
Cycle time	1 ms
Process data length	16 Bit
Process data structure	Bit 0 = switching signal Q _{L1} Bit 1 = switching signal Q _{L2} Bit 2 = switching signal Q _{L3} Bit 3 = switching signal Q _{L4} Bit 4 ... 15 = position (in 50 µm)

Certificates

EU declaration of conformity	✓
UK declaration of conformity	✓
ACMA declaration of conformity	✓
China RoHS	✓
cULus certificate	✓
IO-Link certificate	✓
Information according to Art. 3 of Data Act (Regulation EU 2023/2854)	✓

Classifications

ECLASS 5.0	27270104
ECLASS 5.1.4	27270104
ECLASS 6.0	27270104
ECLASS 6.2	27270104
ECLASS 7.0	27270104
ECLASS 8.0	27270104
ECLASS 8.1	27270104
ECLASS 9.0	27270104
ECLASS 10.0	27270104
ECLASS 11.0	27270104
ECLASS 12.0	27274301
ETIM 5.0	EC002544
ETIM 6.0	EC002544
ETIM 7.0	EC002544
ETIM 8.0	EC002544
UNSPSC 16.0901	39122230

Installation note

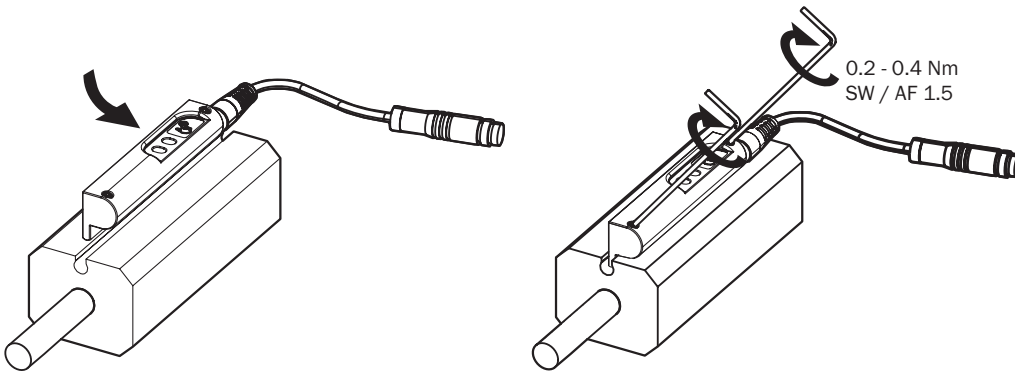

Connection diagram Cd-357

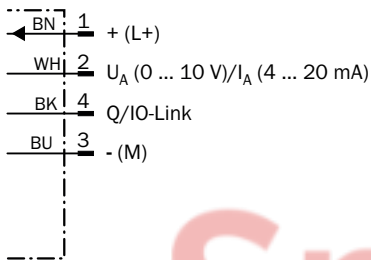

Dimensional drawing Cable with connector M8

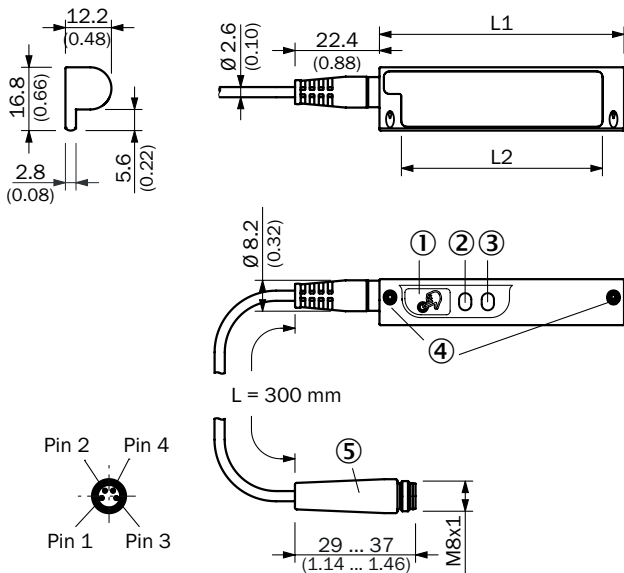



	Total length (L1) mm	Measuring range (L2) mm
MPS-xxx	40.6	25
MPS-xxx	64.9	50
MPS-xxx	114.9	100
MPS-xxx	214.7	200

Dimensions in mm (inch)



- ① Teach-in button
- ② status LEDs
- ③ operating LEDs
- ④ Fixing screw SW 1.5
- ⑤ Connection

Recommended accessories

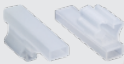
Other models and accessories → www.sick.com/MPS-C

	Brief description	Type	part no.
Mounting systems			
	<ul style="list-style-type: none"> Description: Mounting bracket for integrated profile cylinder/tie-rod cylinder Material: Zinc diecast Details: Zinc diecast Items supplied: Mounting hardware included 	BEF-KHZ-PC1	2076170
	<ul style="list-style-type: none"> Description: Mounting bracket on round body cylinder with piston diameter of 1 mm ... 130 mm, ambient temperature min -30 °C max 80 °C Material: Stainless steel, Aluminum Details: Stainless steel, Aluminum Packing unit: 1 piece Suitable for: C-slot 	BEF-KHZ-RC1-130	2077686
	<ul style="list-style-type: none"> Description: Mounting bracket on round body cylinder with piston diameter of 1 mm ... 25 mm, ambient temperature min -30 °C max 80 °C Material: Stainless steel, Aluminum Details: Stainless steel, Aluminum Packing unit: 1 piece Suitable for: C-slot 	BEF-KHZ-RC1-25	2077685
	<ul style="list-style-type: none"> Description: Label Holder, 2.5 mm to 3.5 mm, 10 pcs. Material: Plastic Details: TPU Packing unit: 10 pieces 	LABEL HOLDER	2086019

SpareCruX

	Brief description	Type	part no.
connectors and cables			
	<ul style="list-style-type: none"> • Connection type head A: Male connector, M8, 4-pin, straight, A-coded • Description: Unshielded • Connection systems: Screw-type terminals • Permitted cross-section: 0.14 mm² ... 0.5 mm² 	STE-0804-G	6037323
	<ul style="list-style-type: none"> • Connection type head A: Female connector, M8, 4-pin, straight, A-coded • Description: Unshielded • Connection systems: Screw-type terminals • Permitted cross-section: 0.14 mm² ... 0.5 mm² 	DOS-0804-G	6009974
	<ul style="list-style-type: none"> • Connection type head A: Female connector, M8, 4-pin, angled, A-coded • Description: Unshielded • Connection systems: Solder connection • Permitted cross-section: ≤ 0.25 mm² 	DOS-0804-W	6009975
	<ul style="list-style-type: none"> • Connection type head A: Female connector, M8, 4-pin, straight, A-coded • Connection type head B: Flying leads • Signal type: Sensor/actuator cable • Cable: 0.6 m, 4-wire, PUR, halogen-free • Description: Sensor/actuator cable, unshielded • Application: Uncontaminated zones, Zones with oils and lubricants, Robot, Drag chain operation 	YF8U14-C60UA3XLEAX	2145825
	<ul style="list-style-type: none"> • Connection type head A: Female connector, M8, 4-pin, straight, A-coded • Connection type head B: Flying leads • Signal type: Sensor/actuator cable • Cable: 1 m, 4-wire, PUR, halogen-free • Description: Sensor/actuator cable, unshielded • Application: Uncontaminated zones, Zones with oils and lubricants, Robot, Drag chain operation 	YF8U14-010UA3XLEAX	2145826
	<ul style="list-style-type: none"> • Connection type head A: Female connector, M8, 4-pin, straight, A-coded • Connection type head B: Male connector, M12, 4-pin, straight, A-coded • Signal type: Sensor/actuator cable • Cable: 1 m, 4-wire, PVC • Description: Sensor/actuator cable, unshielded • Application: Zones with chemicals, Uncontaminated zones 	YF8U14-010VA3M2A14	2145875
	<ul style="list-style-type: none"> • Connection type head A: Female connector, M8, 4-pin, straight, A-coded • Connection type head B: Male connector, M12, 4-pin, straight, A-coded • Signal type: Sensor/actuator cable • Cable: 3 m, 4-wire, PVC • Description: Sensor/actuator cable, unshielded • Application: Zones with chemicals, Uncontaminated zones 	YF8U14-030VA3M2A14	2145876

SICK AT A GLANCE

SICK is one of the leading manufacturers of intelligent sensors and sensor solutions for industrial applications. A unique range of products and services creates the perfect basis for controlling processes securely and efficiently, protecting individuals from accidents and preventing damage to the environment.

We have extensive experience in a wide range of industries and understand their processes and requirements. With intelligent sensors, we can deliver exactly what our customers need. In application centers in Europe, Asia and North America, system solutions are tested and optimized in accordance with customer specifications. All this makes us a reliable supplier and development partner.

Comprehensive services complete our offering: SICK LifeTime Services provide support throughout the machine life cycle and ensure safety and productivity.

For us, that is “Sensor Intelligence.”

WORLDWIDE PRESENCE:

Contacts and other locations – www.sick.com

SpareCruX