



IHM06-02BNSVT0G

IMM

INDUCTIVE PROXIMITY SENSORS

SICK
Sensor Intelligence.



Ordering information

| Type | part no. |
|-----------------|----------|
| IHM06-02BNSVTOG | 1101126 |

Other models and accessories → www.sick.com/IMM

Illustration may differ



Detailed technical data

Features

| | |
|--|-----------------------------|
| Housing | Cylindrical |
| Housing | Extremely short model |
| Diameter | Ø 6.5 mm |
| Sensing range S_n | 2 mm |
| Safe sensing range S_a | 1.62 mm |
| Installation type | Flush |
| Switching frequency | 5,000 Hz |
| Connection type | Connector M8, 3-pin |
| Switching output | NPN |
| Switching output detail | NPN |
| Output function | NO |
| Electrical wiring | DC 3-wire |
| Enclosure rating | IP67 ¹⁾ |
| Special features | Visual adjustment indicator |

¹⁾ According to EN 60529.

Mechanics/electronics

| | |
|---------------------------------------|----------------------|
| Supply voltage | 10 V DC ... 30 V DC |
| Ripple | ≤ 20 % ¹⁾ |
| Voltage drop | ≤ 2 V ²⁾ |
| Time delay before availability | ≤ 50 ms |

¹⁾ Of V_S .

²⁾ With $I_a = 200$ mA.

³⁾ Supply voltage U_B and constant ambient temperature T_a .

| | |
|---|--|
| Hysteresis | 1 % ... 10 % |
| Reproducibility | ≤ 2 % ³⁾ |
| Temperature drift (of S_r) | ≤ 10 % |
| EMC | EN 60947-5-2 |
| Continuous current I_a | ≤ 200 mA |
| Short-circuit protection | ✓ |
| Power-up pulse protection | ✓ |
| Shock and vibration resistance | 30 g, 11 ms / 10 ... 55 Hz, 1 mm |
| Ambient operating temperature | -25 °C ... +70 °C |
| Housing material | Stainless steel V2A, DIN 1.4305 / AISI 303 |
| Sensing face material | Plastic, LCP |
| Housing length | 29 mm |
| UL File No. | NRKH.E348498 |

¹⁾ Of V_S.

²⁾ With I_a = 200 mA.

³⁾ Supply voltage U_B and constant ambient temperature T_a.

Safety-related parameters

| | |
|-------------------------|-------------|
| MTTF_D | 1,330 years |
| DC_{avg} | 0 % |

Reduction factors

| | |
|-----------------------------------|--|
| Note | The values are reference values which may vary |
| St37 steel (Fe) | 1 |
| Stainless steel (V2A, 304) | Approx. 0.75 |
| Aluminum (Al) | Approx. 0.5 |
| Copper (Cu) | Approx. 0.43 |
| Brass (Br) | Approx. 0.54 |

Installation note

| | |
|---------------|---------------------------------------|
| Remark | Associated graphic see "Installation" |
| B | 6 mm |
| C | 6.5 mm |
| D | 6 mm |
| F | 16 mm |

Certificates

| | |
|---|---|
| EU declaration of conformity | ✓ |
| UK declaration of conformity | ✓ |
| ACMA declaration of conformity | ✓ |
| Moroccan declaration of conformity | ✓ |
| China RoHS | ✓ |
| IO-Link certificate | ✓ |

Classifications

| | |
|-----------------------|----------|
| ECLASS 5.0 | 27270101 |
| ECLASS 5.1.4 | 27270101 |
| ECLASS 6.0 | 27270101 |
| ECLASS 6.2 | 27270101 |
| ECLASS 7.0 | 27270101 |
| ECLASS 8.0 | 27270101 |
| ECLASS 8.1 | 27270101 |
| ECLASS 9.0 | 27270101 |
| ECLASS 10.0 | 27270101 |
| ECLASS 11.0 | 27270101 |
| ECLASS 12.0 | 27274001 |
| ETIM 5.0 | EC002714 |
| ETIM 6.0 | EC002714 |
| ETIM 7.0 | EC002714 |
| ETIM 8.0 | EC002714 |
| UNSPSC 16.0901 | 39122230 |

Installation note Mounting using BEF-KH-M06 bracket

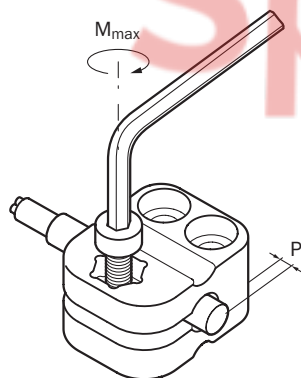

| Sensor type | Mounting adapter | Overrun (P) | Max. tightening torque (M_{max}) |
|--|------------------------------|-------------|--------------------------------------|
| IHM06-1B5***** IHM06-02B***** IHM06-03B***** | BEF-KH-M06, part no. 2101067 | ≥ 0 mm | ≤ 0.6 Nm |

Installation note Fixing with setscrew

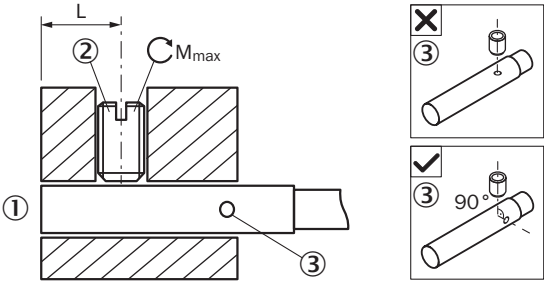

- ① Sensing face
- ② Recommended setscrew: M3, flat point
- ③ Display LED

| Sensor type | Mounting area (L) | Max. tightening torque (M_{max}) |
|----------------|-------------------|--------------------------------------|
| IHM06-*****G | 6 mm ... 11 mm | ≤ 0.4 Nm |
| IHM06-*****TOG | 6 mm ... 21 mm | ≤ 0.4 Nm |
| IHM06-*****K | 6 mm ... 21 mm | ≤ 0.4 Nm |
| IHM06-*****TOK | 6 mm ... 32 mm | ≤ 0.4 Nm |
| IHM06-*****S | 6 mm ... 32 mm | ≤ 0.4 Nm |
| IHM06-*****TOS | 6 mm ... 42 mm | ≤ 0.4 Nm |

Installation note Flush installation

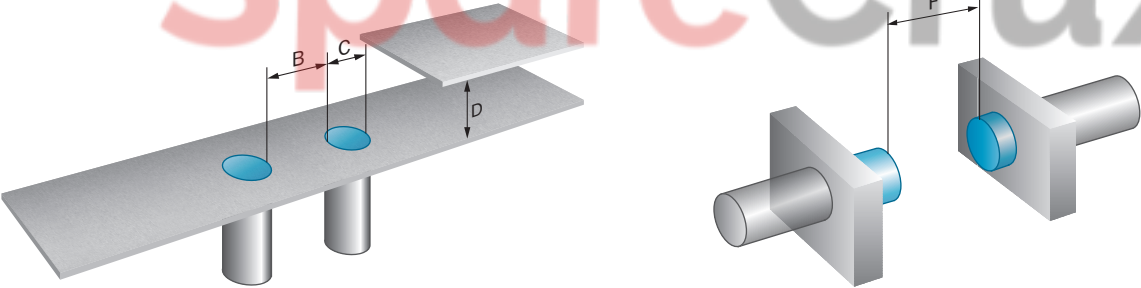

Connection diagram Cd-002

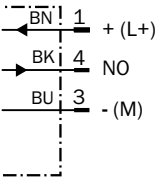

Response diagram



Functional principle Installation aid

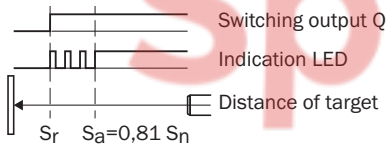

Dimensional drawing IHM06, extremely short variant, flush, male connector

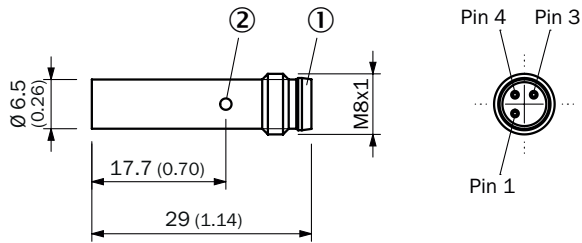

Recommended accessories





Other models and accessories → www.sick.com/IMM

| | Brief description | Type | part no. |
|---|--|------------|----------|
| Mounting systems | | | |
|  | <ul style="list-style-type: none">• Material: Plastic• Details: Plastic (PA6)• Items supplied: Without mounting hardware• Usable for: Round sensors with 6.5 mm housing diameter without fixed stop | BEF-KH-M06 | 2101067 |



| | Brief description | Type | part no. |
|---|---|--------------------|----------|
| connectors and cables | | | |
|  | <ul style="list-style-type: none"> • Number of slots: 4 • Slot connection type: M8, 3-pin, A-coded, female connector • Items supplied: 5 x labeling plates • Description: Unshielded | Y8A34A2-C2A8000XXX | 2115733 |
|  | <ul style="list-style-type: none"> • Number of slots: 4 • Slot connection type: M8, 3-pin, A-coded, female connector • Items supplied: 5 x labeling plates • Cable: 5 m, 6-wire, PUR, halogen-free • Description: Unshielded • Application: Drag chain operation | Y8A34A2-LXXXUAA050 | 2115727 |
|  | <ul style="list-style-type: none"> • Number of slots: 6 • Slot connection type: M8, 3-pin, A-coded, female connector • Items supplied: 5 x labeling plates • Description: Unshielded | Y8A36A2-C2A8000XXX | 2115734 |
|  | <ul style="list-style-type: none"> • Number of slots: 6 • Slot connection type: M8, 3-pin, A-coded, female connector • Items supplied: 5 x labeling plates • Cable: 5 m, 8-wire, PUR, halogen-free • Description: Unshielded • Application: Drag chain operation | Y8A36A2-LXXXUBA050 | 2115728 |
|  | <ul style="list-style-type: none"> • Connection type head A: Female connector, M8, 3-pin, straight, A-coded • Connection type head B: Flying leads • Signal type: Sensor/actuator cable • Cable: 2 m, 3-wire, PUR, halogen-free • Description: Sensor/actuator cable, unshielded • Application: Uncontaminated zones, Zones with oils and lubricants, Robot, Drag chain operation | YF8U13-020UA1XLEAX | 2094782 |
|  | <ul style="list-style-type: none"> • Connection type head A: Female connector, M8, 3-pin, straight, A-coded • Connection type head B: Flying leads • Signal type: Sensor/actuator cable • Cable: 5 m, 3-wire, PUR, halogen-free • Description: Sensor/actuator cable, unshielded • Application: Uncontaminated zones, Zones with oils and lubricants, Robot, Drag chain operation | YF8U13-050UA1XLEAX | 2094788 |
|  | <ul style="list-style-type: none"> • Connection type head A: Female connector, M8, 3-pin, straight, A-coded • Connection type head B: Flying leads • Signal type: Sensor/actuator cable • Cable: 2 m, 3-wire, PVC • Description: Sensor/actuator cable, unshielded • Application: Zones with chemicals, Uncontaminated zones | YF8U13-020VA1XLEAX | 2095860 |
|  | <ul style="list-style-type: none"> • Connection type head A: Female connector, M8, 3-pin, straight, A-coded • Connection type head B: Flying leads • Signal type: Sensor/actuator cable • Cable: 5 m, 3-wire, PVC • Description: Sensor/actuator cable, unshielded • Application: Zones with chemicals, Uncontaminated zones | YF8U13-050VA1XLEAX | 2095884 |
|  | <ul style="list-style-type: none"> • Connection type head A: Female connector, M8, 3-pin, angled, A-coded • Connection type head B: Flying leads • Signal type: Sensor/actuator cable • Cable: 2 m, 3-wire, PUR, halogen-free • Description: Sensor/actuator cable, unshielded • Application: Uncontaminated zones, Zones with oils and lubricants, Robot, Drag chain operation | YG8U13-020UA1XLEAX | 2094794 |
|  | <ul style="list-style-type: none"> • Connection type head A: Female connector, M8, 3-pin, angled, A-coded • Connection type head B: Flying leads • Signal type: Sensor/actuator cable • Cable: 5 m, 3-wire, PUR, halogen-free • Description: Sensor/actuator cable, unshielded • Application: Uncontaminated zones, Zones with oils and lubricants, Robot, Drag chain operation | YG8U13-050UA1XLEAX | 2095586 |
|  | <ul style="list-style-type: none"> • Connection type head A: Female connector, M8, 3-pin, angled, A-coded • Connection type head B: Flying leads • Signal type: Sensor/actuator cable • Cable: 2 m, 3-wire, PVC • Description: Sensor/actuator cable, unshielded | YG8U13-020VA1XLEAX | 2096165 |

| | Brief description | Type | part no. |
|---|---|--------------------|----------|
|  | <ul style="list-style-type: none"> • Application: Zones with chemicals, Untaminated zones • Connection type head A: Female connector, M8, 3-pin, angled, A-coded • Connection type head B: Flying leads • Signal type: Sensor/actuator cable • Cable: 5 m, 3-wire, PVC • Description: Sensor/actuator cable, unshielded • Application: Zones with chemicals, Untaminated zones | YG8U13-050VA1XLEAX | 2096166 |
|  | <ul style="list-style-type: none"> • Connection type head A: Female connector, M8, 3-pin, straight, A-coded • Connection type head B: Male connector, M12, 3-pin, straight, A-coded • Signal type: Sensor/actuator cable • Cable: 2 m, 3-wire, PUR, halogen-free • Description: Sensor/actuator cable, unshielded • Application: Untaminated zones, Zones with oils and lubricants, Robot, Drag chain operation | YF8U13-020UA1M2A13 | 2096169 |
|  | <ul style="list-style-type: none"> • Connection type head A: Female connector, M8, 3-pin, straight, A-coded • Connection type head B: Male connector, M12, 3-pin, straight, A-coded • Signal type: Sensor/actuator cable • Cable: 5 m, 3-wire, PUR, halogen-free • Description: Sensor/actuator cable, unshielded • Application: Untaminated zones, Zones with oils and lubricants, Robot, Drag chain operation | YF8U13-050UA1M2A13 | 2096170 |
|  | <ul style="list-style-type: none"> • Connection type head A: Female connector, M8, 3-pin, straight, A-coded • Connection type head B: Male connector, M12, 3-pin, straight, A-coded • Signal type: Sensor/actuator cable • Cable: 2 m, 3-wire, PVC • Description: Sensor/actuator cable, unshielded • Application: Zones with chemicals, Untaminated zones | YF8U13-020VA1M2A13 | 2096605 |
|  | <ul style="list-style-type: none"> • Connection type head A: Female connector, M8, 3-pin, straight, A-coded • Connection type head B: Male connector, M12, 3-pin, straight, A-coded • Signal type: Sensor/actuator cable • Cable: 5 m, 3-wire, PVC • Description: Sensor/actuator cable, unshielded • Application: Zones with chemicals, Untaminated zones | YF8U13-050VA1M2A13 | 2096606 |
|  | <ul style="list-style-type: none"> • Connection type head A: Female connector, M8, 3-pin, angled, A-coded • Connection type head B: Male connector, M12, 3-pin, straight, A-coded • Signal type: Sensor/actuator cable • Cable: 2 m, 3-wire, PUR, halogen-free • Description: Sensor/actuator cable, unshielded • Application: Untaminated zones, Zones with oils and lubricants, Robot, Drag chain operation | YG8U13-020UA1M2A13 | 2095748 |
|  | <ul style="list-style-type: none"> • Connection type head A: Female connector, M8, 3-pin, straight, A-coded • Connection type head B: Male connector, M8, 3-pin, straight, A-coded • Signal type: Sensor/actuator cable • Cable: 2 m, 3-wire, PUR, halogen-free • Description: Sensor/actuator cable, unshielded • Application: Untaminated zones, Zones with oils and lubricants, Robot, Drag chain operation | YF8U13-020UA1M8U13 | 2096304 |
|  | <ul style="list-style-type: none"> • Connection type head A: Female connector, M8, 3-pin, straight, A-coded • Connection type head B: Male connector, M8, 3-pin, straight, A-coded • Signal type: Sensor/actuator cable • Cable: 5 m, 3-wire, PUR, halogen-free • Description: Sensor/actuator cable, unshielded • Application: Untaminated zones, Zones with oils and lubricants, Robot, Drag chain operation | YF8U13-050UA1M8U13 | 2096308 |
|  | <ul style="list-style-type: none"> • Connection type head A: Female connector, M8, 3-pin, angled, A-coded • Connection type head B: Male connector, M8, 3-pin, straight, A-coded • Signal type: Sensor/actuator cable • Cable: 2 m, 3-wire, PUR, halogen-free • Description: Sensor/actuator cable, unshielded • Application: Untaminated zones, Zones with oils and lubricants, Robot, Drag chain operation | YG8U13-020UA1M8U13 | 2107781 |
|  | <ul style="list-style-type: none"> • Connection type head A: Female connector, M8, 3-pin, angled, A-coded • Connection type head B: Male connector, M12, 3-pin, straight, A-coded • Signal type: Sensor/actuator cable • Cable: 5 m, 3-wire, PUR, halogen-free • Description: Sensor/actuator cable, unshielded • Application: Untaminated zones, Zones with oils and lubricants, Robot, Drag chain operation | YG8U13-050UA1M2A13 | 2122842 |
|  | <ul style="list-style-type: none"> • Connection type head A: Female connector, M8, 3-pin, straight, A-coded • Connection type head B: Male connector, M12, 3-pin, straight, A-coded • Signal type: Sensor/actuator cable • Cable: 3 m, 3-wire, PUR, halogen-free • Description: Sensor/actuator cable, unshielded | YF8U13-030UA1M2A13 | 2144589 |

| | Brief description | Type | part no. |
|---|--|--------------------|----------|
|  | <ul style="list-style-type: none"> Application: Untaminated zones, Zones with oils and lubricants, Robot, Drag chain operation Connection type head A: Female connector, M8, 3-pin, angled, A-coded Connection type head B: Flying leads Signal type: Sensor/actuator cable Cable: 0.6 m, 3-wire, PUR, halogen-free Description: Sensor/actuator cable, unshielded Application: Untaminated zones, Zones with oils and lubricants, Robot, Drag chain operation | YG8U13-C60UA1XLEAX | 2145889 |
|  | <ul style="list-style-type: none"> Connection type head A: Female connector, M8, 3-pin, angled, A-coded Connection type head B: Flying leads Signal type: Sensor/actuator cable Cable: 3 m, 3-wire, PUR, halogen-free Description: Sensor/actuator cable, unshielded Application: Untaminated zones, Zones with oils and lubricants, Robot, Drag chain operation | YG8U13-030UA1XLEAX | 2145891 |
|  | <ul style="list-style-type: none"> Connection type head A: Female connector, M8, 3-pin, straight, A-coded Connection type head B: Flying leads Signal type: Sensor/actuator cable Cable: 0.6 m, 3-wire, PVC Description: Sensor/actuator cable, unshielded Application: Zones with chemicals, Untaminated zones | YF8U13-C60VA1XLEAX | 2146368 |
|  | <ul style="list-style-type: none"> Connection type head A: Female connector, M8, 3-pin, straight, A-coded Connection type head B: Male connector, M12, 3-pin, straight, A-coded Signal type: Sensor/actuator cable Cable: 1 m, 3-wire, PVC Description: Sensor/actuator cable, unshielded Application: Zones with chemicals, Untaminated zones | YF8U13-010VA1M2A13 | 2146381 |

SpareCruX

SICK AT A GLANCE

SICK is one of the leading manufacturers of intelligent sensors and sensor solutions for industrial applications. A unique range of products and services creates the perfect basis for controlling processes securely and efficiently, protecting individuals from accidents and preventing damage to the environment.

We have extensive experience in a wide range of industries and understand their processes and requirements. With intelligent sensors, we can deliver exactly what our customers need. In application centers in Europe, Asia and North America, system solutions are tested and optimized in accordance with customer specifications. All this makes us a reliable supplier and development partner.

Comprehensive services complete our offering: SICK LifeTime Services provide support throughout the machine life cycle and ensure safety and productivity.

For us, that is “Sensor Intelligence.”

WORLDWIDE PRESENCE:

Contacts and other locations – www.sick.com

SpareCruX