



Spare part

MZT8-2V8PS-KRXS36

MZT8 ATEX

CYLINDER SENSORS

SICK
Sensor Intelligence.



Ordering information

Type	part no.
MZT8-2V8PS-KRXS36	1109959

Other models and accessories → www.sick.com/MZT8_ATEX



Detailed technical data

Features

Cylinder type	T-slot
Cylinder types with adapter	Profile cylinder Tie rod cylinder Round body cylinder Dovetail groove cylinder SMC rail CDQ2 SMC rail ECDQ2
Housing length	24 mm
Switching output	PNP
Switching frequency	1,000 Hz
Output function	NO
Electrical wiring	DC 3-wire
Enclosure rating	IP67 ¹⁾

¹⁾ According to EN 60529 (IP 67 / IP 68).

Mechanics/electronics

Supply voltage	10 V DC ... 26 V DC ¹⁾
Power consumption	10 mA, without load
Voltage drop	≤ 2.2 V
Continuous current I_a	≤ 50 mA ¹⁾
Ex area category	3G, 3D
Device labeling	II 3G Ex nA IIC T4 Gc X, II 3D Ex tc IIIC T135 °C Dc X
Response sensitivity, typ.	2.8 mT
Overrun distance, typ.	9 mm

¹⁾ Depend on ambient temperature. For details see operating instructions under „performance data of the sensor“.

²⁾ Supply voltage U_B and constant ambient temperature T_a.

Hysteresis, typ.	0.7 mT
Reproducibility	≤ 0.1 mT ²⁾
Reverse polarity protection	Yes
Short-circuit protection	Yes
Status indicator LED	Yes
Teach-in	No
Power-up pulse protection	Yes
Ambient operating temperature	-20 °C ... +50 °C
Shock and vibration resistance	30 g, 11 ms / 10 ... 55 Hz, 1 mm
EMC	According to EN 60947-5-2
Connection type	Cable with plug M8, 3-pin, with knurled nut, 0.3 m
Connection type Detail	
Conductor cross section	0.14 mm ²
Cable diameter	Ø 2.9 mm
Bending radius	With fixed installation > 3 x cable diameter For flexible use > 10 x cable diameter
Torsion force	± 270° / 10 cm
Torsion cycles	> 2,000,000
Cable outlet	Axial
Material	
Housing	Plastic, PA12
Cable	PUR
Items supplied	Safety clip
UL File No.	E181493

¹⁾ Depend on ambient temperature. For details see operating instructions under „performance data of the sensor“.

²⁾ Supply voltage U_B and constant ambient temperature T_a .

Certificates

EU declaration of conformity	✓
UK declaration of conformity	✓
ACMA declaration of conformity	✓
Moroccan declaration of conformity	✓
China RoHS	✓

Classifications

ECLASS 5.0	27270104
ECLASS 5.1.4	27270104
ECLASS 6.0	27270104
ECLASS 6.2	27270104
ECLASS 7.0	27270104
ECLASS 8.0	27270104
ECLASS 8.1	27270104
ECLASS 9.0	27270104

ECLASS 10.0	27270104
ECLASS 11.0	27270104
ECLASS 12.0	27274301
ETIM 5.0	EC002544
ETIM 6.0	EC002544
ETIM 7.0	EC002544
ETIM 8.0	EC002544
UNSPSC 16.0901	39122230

Installation note

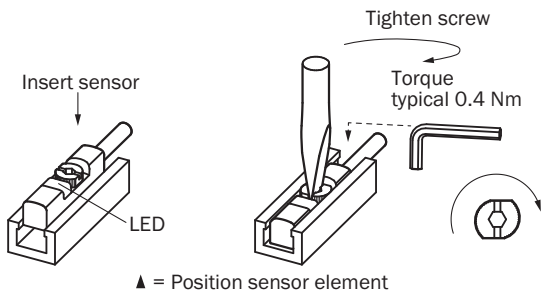

Connection diagram Cd-308

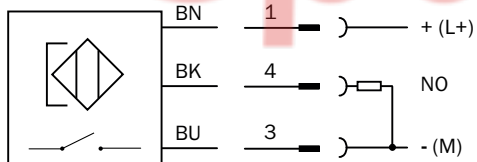

Dimensional drawing Cable with connector M8

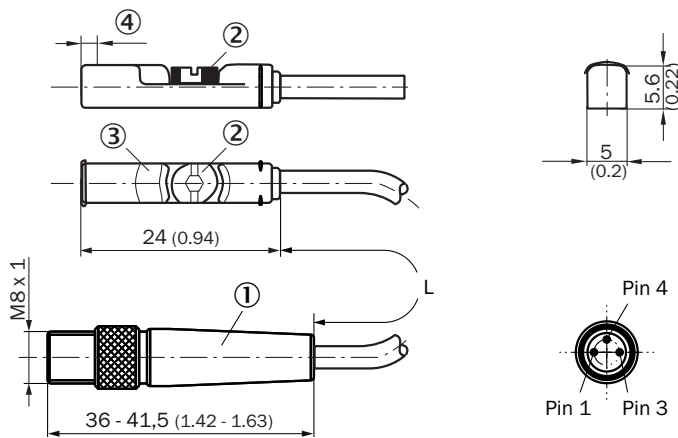

Dimensions in mm (inch)

① Connection

- ② Fixing screw SW 2.0
- ③ Display LED
- ④ sensor element position = long overrun distance (9 mm): 1.5 mm







Part no.	Type	L	Number of cores
1109959	MZT8-2V8PS-KRXS36	300 mm	3

SpareCruX

Recommended accessories

Other models and accessories → www.sick.com/MZT8_ATEX

	Brief description	Type	part no.
Mounting systems			
	<ul style="list-style-type: none"> Description: Mounting bracket for integrated profile cylinder/tie-rod cylinder Material: Zinc diecast Details: Zinc diecast Items supplied: Mounting hardware included 	BEF-KHZ-PT1	2022702
	<ul style="list-style-type: none"> Description: Mounting bracket for cylinder with dovetail slot Material: Aluminum Details: Aluminum Items supplied: Without mounting hardware 	BEF-KHZ-ST1	2022703
	<ul style="list-style-type: none"> Description: Mounting bracket for mounting on SMC rails ECDQ2 (T-slot) Material: Aluminum Details: Aluminum Items supplied: Without mounting hardware 	BEF-KHZ-TT1	2046439
	<ul style="list-style-type: none"> Description: Mounting bracket for mounting on SMC rails CDQ2 (T-slot) Material: Aluminum Details: Aluminum Items supplied: Without mounting hardware 	BEF-KHZ-TT2	2046440
	<ul style="list-style-type: none"> Description: Mounting bracket on round body cylinder with piston diameter of 8 mm ... 130 mm, ambient temperature min -30 °C max 80 °C Material: Stainless steel, Zinc cast Details: Stainless steel, Zinc cast Packing unit: 1 piece Suitable for: T-slot 	BEF-KHZ-RT1-130	2077684
	<ul style="list-style-type: none"> Description: Mounting bracket on round body cylinder with piston diameter of 12 mm, ambient temperature min 0 °C max 50 °C Dimensions (W x H x L): 22.4 m Material: Plastic, Aluminum Details: Plastic, Aluminum Packing unit: 1 piece Suitable for: T-slot 	BEF-KHZ-RT-12	2077681
	<ul style="list-style-type: none"> Description: Mounting bracket on round body cylinder with piston diameter of 8 mm ... 25 mm, ambient temperature min -30 °C max 80 °C Material: Stainless steel, Zinc cast Details: Stainless steel, Zinc cast Packing unit: 1 piece Suitable for: T-slot 	BEF-KHZ-RT1-25	2077682
	<ul style="list-style-type: none"> Description: Mounting bracket on round body cylinder with piston diameter of 16 mm, ambient temperature min 0 °C max 50 °C Dimensions (W x H x L): 26.6 m Material: Plastic, Aluminum Details: Plastic, Aluminum Packing unit: 1 piece Suitable for: T-slot 	BEF-KHZ-RT-16	2077680
	<ul style="list-style-type: none"> Description: Mounting bracket on round body cylinder with piston diameter of 8 mm ... 63 mm, ambient temperature min -30 °C max 80 °C Material: Stainless steel, Zinc cast Details: Stainless steel, Zinc cast Packing unit: 1 piece Suitable for: T-slot 	BEF-KHZ-RT1-63	2077683
	<ul style="list-style-type: none"> Description: Mounting bracket on round body cylinder with piston diameter of 20 mm, ambient temperature min 0 °C max 50 °C Dimensions (W x H x L): 30.6 m Material: Plastic, Aluminum Details: Plastic, Aluminum Packing unit: 1 piece 	BEF-KHZ-RT-20	2077679

	Brief description	Type	part no.
	<ul style="list-style-type: none"> • Suitable for: T-slot • Description: Mounting bracket on round body cylinder with piston diameter of 25 mm, ambient temperature min 0 °C max 50 °C • Dimensions (W x H x L): 35.7 m • Material: Plastic, Aluminum • Details: Plastic, Aluminum • Packing unit: 1 piece • Suitable for: T-slot 	BEF-KHZ-RT-25	2077678
	<ul style="list-style-type: none"> • Description: Mounting bracket on round body cylinder with piston diameter of 32 mm, ambient temperature min 0 °C max 50 °C • Dimensions (W x H x L): 42.9 m • Material: Plastic, Aluminum • Details: Plastic, Aluminum • Packing unit: 1 piece • Suitable for: T-slot 	BEF-KHZ-RT-32	2077677
	<ul style="list-style-type: none"> • Description: Mounting bracket on round body cylinder with piston diameter of 40 mm, ambient temperature min 0 °C max 50 °C • Dimensions (W x H x L): 50.9 m • Material: Plastic, Aluminum • Details: Plastic, Aluminum • Packing unit: 1 piece • Suitable for: T-slot 	BEF-KHZ-RT-40	2077676
	<ul style="list-style-type: none"> • Description: Mounting bracket on round body cylinder with piston diameter of 50 mm, ambient temperature min 0 °C max 50 °C • Dimensions (W x H x L): 61.8 m • Material: Plastic, Aluminum • Details: Plastic, Aluminum • Packing unit: 1 piece • Suitable for: T-slot 	BEF-KHZ-RT-50	2077675
	<ul style="list-style-type: none"> • Description: Mounting bracket on round body cylinder with piston diameter of 63 mm, ambient temperature min 0 °C max 50 °C • Dimensions (W x H x L): 73.9 m • Material: Plastic, Aluminum • Details: Plastic, Aluminum • Packing unit: 1 piece • Suitable for: T-slot 	BEF-KHZ-RT-63	2077674
device protection and care			
	<ul style="list-style-type: none"> • Description: Protective adapter • Material: Zinc diecast • Items supplied: Mounting hardware included • Suitable for: MZT7, RZT7, MZT8 	BEF-SG-MRZT	2077201

	Brief description	Type	part no.
connectors and cables			
	<ul style="list-style-type: none"> • Connection type head A: Male connector, M8, 3-pin, straight, A-coded • Description: Unshielded • Connection systems: Screw-type terminals • Permitted cross-section: 0.14 mm² ... 0.5 mm² 	STE-0803-G	6037322
	<ul style="list-style-type: none"> • Connection type head A: Female connector, M8, 3-pin, straight, A-coded • Description: Unshielded • Connection systems: Screw-type terminals • Permitted cross-section: 0.14 mm² ... 0.5 mm² 	DOS-0803-G	7902077
	<ul style="list-style-type: none"> • Connection type head A: Female connector, M8, 3-pin, angled, A-coded • Description: Unshielded • Connection systems: Solder connection • Permitted cross-section: ≤ 0.25 mm² 	DOS-0803-W	7902078
	<ul style="list-style-type: none"> • Connection type head A: Female connector, M8, 3-pin, straight, A-coded • Connection type head B: Flying leads • Signal type: Sensor/actuator cable • Cable: 2 m, 3-wire, PVC • Description: Sensor/actuator cable, unshielded • Application: Zones with chemicals, Uncontaminated zones 	YF8U13-020VA1XLEAX	2095860
	<ul style="list-style-type: none"> • Connection type head A: Female connector, M8, 3-pin, straight, A-coded • Connection type head B: Flying leads • Signal type: Sensor/actuator cable • Cable: 5 m, 3-wire, PVC • Description: Sensor/actuator cable, unshielded • Application: Zones with chemicals, Uncontaminated zones 	YF8U13-050VA1XLEAX	2095884
	<ul style="list-style-type: none"> • Connection type head A: Female connector, M8, 3-pin, angled, A-coded • Connection type head B: Flying leads • Signal type: Sensor/actuator cable • Cable: 2 m, 3-wire, PVC • Description: Sensor/actuator cable, unshielded • Application: Zones with chemicals, Uncontaminated zones 	YG8U13-020VA1XLEAX	2096165
	<ul style="list-style-type: none"> • Connection type head A: Female connector, M8, 3-pin, angled, A-coded • Connection type head B: Flying leads • Signal type: Sensor/actuator cable • Cable: 5 m, 3-wire, PVC • Description: Sensor/actuator cable, unshielded • Application: Zones with chemicals, Uncontaminated zones 	YG8U13-050VA1XLEAX	2096166
	<ul style="list-style-type: none"> • Connection type head A: Female connector, M8, 3-pin, straight, A-coded • Connection type head B: Flying leads • Signal type: Sensor/actuator cable • Cable: 0.6 m, 3-wire, PVC • Description: Sensor/actuator cable, unshielded • Application: Zones with chemicals, Uncontaminated zones 	YF8U13-C60VA1XLEAX	2146368

SICK AT A GLANCE

SICK is one of the leading manufacturers of intelligent sensors and sensor solutions for industrial applications. A unique range of products and services creates the perfect basis for controlling processes securely and efficiently, protecting individuals from accidents and preventing damage to the environment.

We have extensive experience in a wide range of industries and understand their processes and requirements. With intelligent sensors, we can deliver exactly what our customers need. In application centers in Europe, Asia and North America, system solutions are tested and optimized in accordance with customer specifications. All this makes us a reliable supplier and development partner.

Comprehensive services complete our offering: SICK LifeTime Services provide support throughout the machine life cycle and ensure safety and productivity.

For us, that is “Sensor Intelligence.”

WORLDWIDE PRESENCE:

Contacts and other locations – www.sick.com

SpareCruX