



SpareCruX

# WTT4SLC-3B0062B02

WTT4 PowerProx

TIME-OF-FLIGHT SENSORS

**SICK**  
Sensor Intelligence.



Illustration may differ



### Ordering information

Type	part no.
WTT4SLC-3B0062B02	1111161

Other models and accessories → [www.sick.com/WTT4\\_PowerProx](http://www.sick.com/WTT4_PowerProx)

### Detailed technical data

#### Features

<b>Functional principle</b>	Photoelectric proximity sensor
<b>Functional principle detail</b>	Background suppression, Optical time-of-flight, distance value
<b>Housing design (light emission)</b>	Rectangular
<b>Sensing range max.</b>	50 mm ... 1,300 mm <sup>1)</sup>
<b>Sensing range</b>	100 mm ... 1,300 mm <sup>2)</sup>
<b>Distance value</b>	
Measuring range	90 mm ... 1,300 mm <sup>1)</sup>
Resolution	1,000 µm
Repeatability	4,5 mm ... 11 mm <sup>3) 4) 5)</sup>
Accuracy	- 10 mm, + 80 mm
Distance value output	Via IO-Link
Update rate of the distance value	0.8 ms
<b>Type of light</b>	Visible red light
<b>Light source</b>	Laser <sup>6)</sup>
<b>Light spot size (distance)</b>	Ø 4 mm (1,000 mm)

<sup>1)</sup> Object with 6 ... 90% remission (based on standard white, DIN 5033).

<sup>2)</sup> Adjustable.

<sup>3)</sup> Equivalent to 1  $\sigma$ .

<sup>4)</sup> See characteristic curves repeatability.

<sup>5)</sup> 6% ... 90% remission factor.

<sup>6)</sup> Average service life: 50,000 h at T<sub>U</sub> = +25 °C.

<b>Wave length</b>	658 nm
<b>Laser class</b>	1 (IEC 60825-1 / CDRH 21 CFR 1040.10 & 1040.11)
<b>Adjustment</b>	Single teach-in button, IO-Link
<b>Pin 2 configuration</b>	External input, Teach-in input, Sender off input, Detection output, logic output
<b>Safety-related parameters</b>	
	MTTF <sub>D</sub> 256 years
	DC <sub>avg</sub> 0 %
	T <sub>M</sub> (mission time) 20 years

1) Object with 6 ... 90% remission (based on standard white, DIN 5033).

2) Adjustable.

3) Equivalent to 1  $\sigma$ .

4) See characteristic curves repeatability.

5) 6% ... 90% remission factor.

6) Average service life: 50,000 h at T<sub>U</sub> = +25 °C.

## Interfaces

<b>Communication interface</b>	IO-Link V1.1
<b>Communication Interface detail</b>	COM3 (230,4 kBaud)
<b>Cycle time</b>	0.8 ms
<b>Process data length</b>	4 Byte
<b>Process data structure</b>	Bit 0 = switching signal Q <sub>L1</sub> Bit 1 = switching signal Q <sub>L2</sub> Bit 2 = detection signal Q <sub>int.1</sub> Bit 3 = detection signal Q <sub>int.2</sub> Bit 4 = detection signal Q <sub>int.3</sub> Bit 5 = detection signal Q <sub>int.4</sub> Bit 6 = detection signal Q <sub>int.5</sub> Bit 7 = detection signal Q <sub>int.6</sub> Bit 8 = detection signal Q <sub>int.7</sub> Bit 9 = detection signal Q <sub>int.8</sub> Bit 10 ... 15 = empty Bit 16 ... 31 = distance value
<b>VendorID</b>	26
<b>DeviceID HEX</b>	0x80021D
<b>DeviceID DEC</b>	8389149

## Electronics

<b>Supply voltage U<sub>B</sub></b>	10 V DC ... 30 V DC <sup>1)</sup>
<b>Ripple</b>	< 5 V <sub>pp</sub> <sup>2)</sup>
<b>Current consumption</b>	25 mA <sup>3)</sup>
<b>Switching output</b>	Push-pull: PNP/NPN

1) Limit values. Operated in short-circuit protected network: max. 8 A.

2) May not fall below or exceed U<sub>y</sub> tolerances.

3) Without load.

4) Signal transit time with resistive load.

5) With light/dark ratio 1:1.

6) A = V<sub>S</sub> connections reverse-polarity protected.

7) B = output reverse-polarity protected.

8) D = outputs overcurrent and short-circuit protected.

9) Below T<sub>U</sub> = -10 °C a warm-up time is necessary.

<b>Output function</b>	Factory setting: Pin 2 / white (MF): NPN normally open (light switching), PNP normally closed (dark switching), Pin 4 / black (QL1 / C): NPN normally closed (dark switching), PNP normally open (light switching), IO-Link
<b>Switching mode</b>	Light/dark switching
<b>Output current <math>I_{max}</math></b>	$\leq 50$ mA
<b>Response time</b>	$\leq 5$ ms <sup>4)</sup>
<b>Switching frequency</b>	100 Hz <sup>5)</sup>
<b>Input</b>	MF <sub>in</sub> = multifunctional input programmable
<b>Circuit protection</b>	A <sup>6)</sup> B <sup>7)</sup> D <sup>8)</sup>
<b>Protection class</b>	III
<b>Enclosure rating</b>	IP67
<b>Warm-up time</b>	< 10 min <sup>9)</sup>
<b>Initialization time</b>	< 300 ms

<sup>1)</sup> Limit values. Operated in short-circuit protected network: max. 8 A.

<sup>2)</sup> May not fall below or exceed  $U_V$  tolerances.

<sup>3)</sup> Without load.

<sup>4)</sup> Signal transit time with resistive load.

<sup>5)</sup> With light/dark ratio 1:1.

<sup>6)</sup> A =  $V_S$  connections reverse-polarity protected.

<sup>7)</sup> B = output reverse-polarity protected.

<sup>8)</sup> D = outputs overcurrent and short-circuit protected.

<sup>9)</sup> Below  $T_u = -10$  °C a warm-up time is necessary.

### Mechanics

<b>Dimensions (W x H x D)</b>	12.2 mm x 41.8 mm x 17.3 mm
<b>Housing material</b>	Plastic, MABS ABS
<b>Optics material</b>	Plastic, PMMA
<b>Weight</b>	10 g
<b>Connection type</b>	Cable with M8 male connector, 4-pin, 65 mm
<b>Connection type Detail</b>	
Cable diameter	Ø 3.4 mm
Conductor cross section	0.14 mm <sup>2</sup>

### Ambient data

<b>Ambient operating temperature</b>	-40 °C ... +50 °C <sup>1)</sup>
<b>Ambient temperature, storage</b>	-40 °C ... +75 °C

<sup>1)</sup> As of  $T_a = 45$  °C, a max.load current  $I_{max} = 50$  mA is permitted.

### Smart Task

<b>Smart Task name</b>	Base logics
<b>Logic function</b>	Direct AND OR WINDOW Hysteresis

<b>Timer function</b>	Deactivated Switch-on delay Off delay ON and OFF delay Impulse (one shot)
<b>Inverter</b>	Yes
<b>Switching signal</b>	
Switching signal Q <sub>L1</sub>	Switching output
Switching signal Q <sub>L2</sub>	Switching output

### Classifications

<b>ECLASS 5.0</b>	27270904
<b>ECLASS 5.1.4</b>	27270904
<b>ECLASS 6.0</b>	27270904
<b>ECLASS 6.2</b>	27270904
<b>ECLASS 7.0</b>	27270904
<b>ECLASS 8.0</b>	27270904
<b>ECLASS 8.1</b>	27270904
<b>ECLASS 9.0</b>	27270904
<b>ECLASS 10.0</b>	27270904
<b>ECLASS 11.0</b>	27270904
<b>ECLASS 12.0</b>	27270903
<b>ETIM 5.0</b>	EC002719
<b>ETIM 6.0</b>	EC002719
<b>ETIM 7.0</b>	EC002719
<b>ETIM 8.0</b>	EC002719
<b>UNSPSC 16.0901</b>	39121528

### Certificates

<b>EU declaration of conformity</b>	✓
<b>UK declaration of conformity</b>	✓
<b>ACMA declaration of conformity</b>	✓
<b>Moroccan declaration of conformity</b>	✓
<b>China RoHS</b>	✓
<b>cULus certificate</b>	✓
<b>IO-Link certificate</b>	✓
<b>Laser safety (IEC 60825-1) certificate</b>	✓
<b>Information according to Art. 3 of Data Act (Regulation EU 2023/2854)</b>	✓

### Dimensional drawing

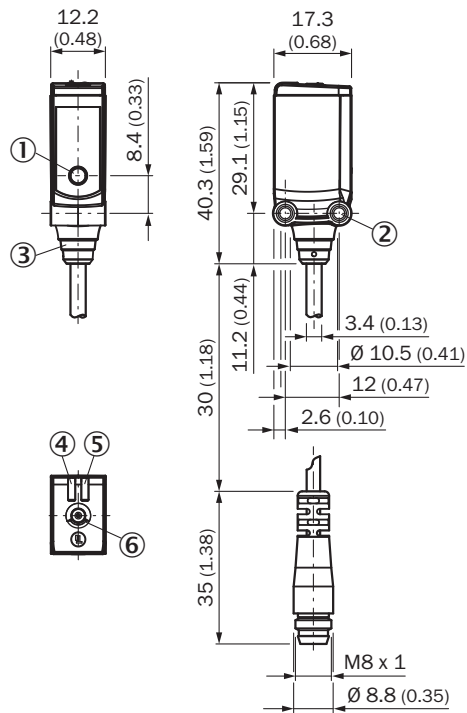

Dimensions in mm (inch)

- ① Center of optical axis
- ② Threaded mounting hole M3
- ③ Connection
- ④ LED indicator green: power
- ⑤ LED indicator yellow: Status of received light beam
- ⑥ single teach-in button

### Connection diagram Cd-390

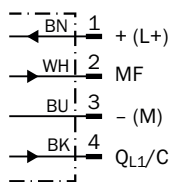

Characteristic curve

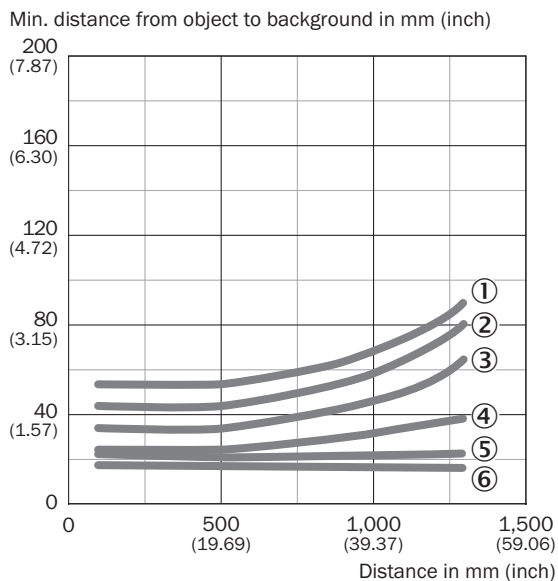

- ① 90 % / 90 % AVG1
- ② 90 % / 90 % AVG2
- ③ 90 % / 90 % AVG4
- ④ 90 % / 90 % AVG8
- ⑤ 90 % / 90 % AVG64
- ⑥ 90 % / 90 % AVG512



Characteristic curve

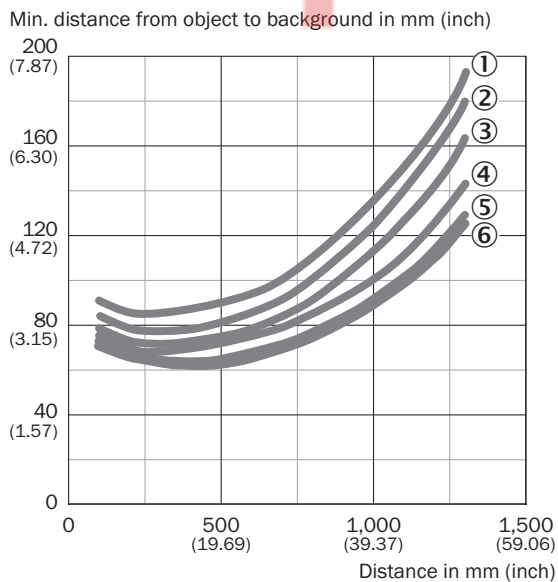

- ① 6 % / 90 % AVG1
- ② 6 % / 90 % AVG2
- ③ 6 % / 90 % AVG4
- ④ 6 % / 90 % AVG8
- ⑤ 6 % / 90 % AVG64
- ⑥ 6 % / 90 % AVG512

Light spot size



- ① Light spot horizontal
- ② Light spot vertical

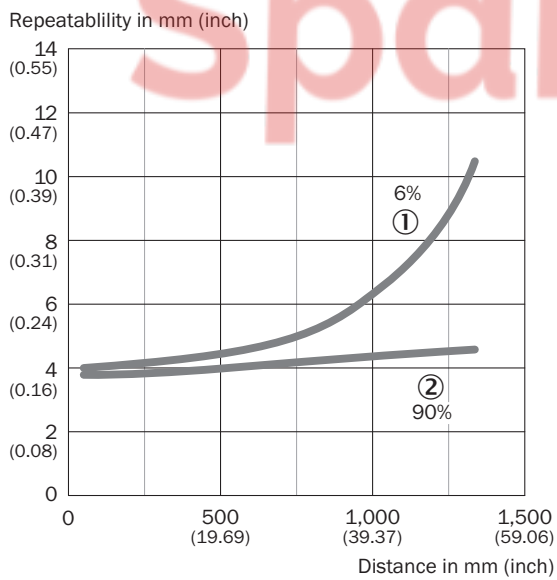

Repeatability



- ① 6 % remission, on black
- ② 90 % remission, on white

## Recommended accessories

Other models and accessories → [www.sick.com/WTT4\\_PowerProx](http://www.sick.com/WTT4_PowerProx)

	Brief description	Type	part no.
Mounting systems			
	<ul style="list-style-type: none"> <li><b>Description:</b> Plate N08N for universal clamp bracket</li> <li><b>Material:</b> Stainless steel, stainless steel</li> <li><b>Details:</b> Stainless steel 1.4571 (sheet), Stainless steel 1.4408 (clamp)</li> <li><b>Items supplied:</b> Universal clamp (5322627), mounting hardware</li> <li><b>Usable for:</b> W100, W150, W4-3, W4S-3, W8, W9-3, W8G, W8 Laser, W8 Inox, G6, W100 Laser, W100-2, W4-3 Glass, W4S-3 Glass, RAY10, W4SLG-3, W9, GR18, MultiPulse, Reflex Array, Multi-Line, LUT3, KT5, KT8, KT10, CS8, G6 Inox</li> </ul>	BEF-KHS-N08N	2051616
connectors and cables			
	<ul style="list-style-type: none"> <li><b>Connection type head A:</b> Male connector, M8, 4-pin, straight, A-coded</li> <li><b>Description:</b> Unshielded</li> <li><b>Connection systems:</b> Screw-type terminals</li> <li><b>Permitted cross-section:</b> 0.14 mm<sup>2</sup> ... 0.5 mm<sup>2</sup></li> </ul>	STE-0804-G	6037323
	<ul style="list-style-type: none"> <li><b>Connection type head A:</b> Female connector, M8, 4-pin, straight, A-coded</li> <li><b>Connection type head B:</b> Flying leads</li> <li><b>Signal type:</b> Sensor/actuator cable</li> <li><b>Cable:</b> 5 m, 4-wire, PVC</li> <li><b>Description:</b> Sensor/actuator cable, unshielded</li> <li><b>Application:</b> Zones with chemicals, Uncontaminated zones</li> </ul>	YF8U14-050VA3XLEAX	2095889

# SpareCruX

## SICK AT A GLANCE

SICK is one of the leading manufacturers of intelligent sensors and sensor solutions for industrial applications. A unique range of products and services creates the perfect basis for controlling processes securely and efficiently, protecting individuals from accidents and preventing damage to the environment.

We have extensive experience in a wide range of industries and understand their processes and requirements. With intelligent sensors, we can deliver exactly what our customers need. In application centers in Europe, Asia and North America, system solutions are tested and optimized in accordance with customer specifications. All this makes us a reliable supplier and development partner.

Comprehensive services complete our offering: SICK LifeTime Services provide support throughout the machine life cycle and ensure safety and productivity.

For us, that is “Sensor Intelligence.”

### WORLDWIDE PRESENCE:

Contacts and other locations – [www.sick.com](http://www.sick.com)

SpareCruX