



SpareCruX

MPA-107THNU0S01

MPA

CYLINDER SENSORS

SICK
Sensor Intelligence.



Ordering information

Type	part no.
MPA-107THNU0S01	1112567

Other models and accessories → www.sick.com/MPA



Detailed technical data

Features

Cylinder type	Universal
Cylinder types with adapter	Round body cylinder Tie rod cylinder T-slot cylinders Festo cylinders DSBC SMC cylinders CP96
Measuring range	107 mm ¹⁾
Housing length	109 mm
Output function	Analog
Electrical wiring	DC 4-wire
Analog output (voltage)	0 V ... 10 V
Enclosure rating	IP65 ²⁾ IP67 IP68

¹⁾ ± 1 mm.

²⁾ According to EN 60529.

Mechanics/electronics

Supply voltage	15 V DC ... 30 V DC
Power consumption	35 mA, without load
Min. load resistance	≥ 2 kΩ ¹⁾
Protection class	III
Required magnetic field sensitivity, typ.	2 mT ... 15 mT
Resolution, typ.	0.03 % FSR (max. ≥ 0.06 mm) ²⁾
Linearity error, typ.	0.5 mm ³⁾

¹⁾ Voltage output.

²⁾ FSR: Full Scale Range; max. measuring range.

³⁾ At 25 ° C, linearity error (maximum deviation) depending on response curve and minimal deviation function.

⁴⁾ At 25 ° C, repeatability magnet movement in one direction.

⁵⁾ The analog measured value can deviate under transient conditions.

Repeat accuracy, typ.	0.06 % FSR (≥ 0.1 mm) ⁴⁾
Sampling rate, typ.	1.15 ms
Reverse polarity protection	Yes
Short-circuit protection	Yes
Status indicator LED	Yes
Teach-in	Yes
Ambient operating temperature	-20 °C ... +70 °C
Shock and vibration resistance	30 g, 11 ms/10 Hz ... 55 Hz, 1 mm
EMC	According to EN 60947-5-2 ⁵⁾
Connection type	Cable, 4-wire, stripped, 2 m
Connection type Detail	
Deep-freeze property	Do not bend below 0 °C
Conductor cross section	0.08 mm ²
Cable diameter	Ø 2.6 mm
Bending radius	With fixed installation > 5 x cable diameter For flexible use > 10 x cable diameter
Cable outlet	Axial
Material	
Housing	Metal, Aluminum Plastic
Cable	PUR
UL File No.	NRKH.E181493 & NRKH7.E181493

1) Voltage output.

2) FSR: Full Scale Range; max. measuring range.

3) At 25 °C, linearity error (maximum deviation) depending on response curve and minimal deviation function.

4) At 25 °C, repeatability magnet movement in one direction.

5) The analog measured value can deviate under transient conditions.

Certificates

EU declaration of conformity	✓
UK declaration of conformity	✓
ACMA declaration of conformity	✓
Moroccan declaration of conformity	✓
China RoHS	✓
cULus certificate	✓

Classifications

ECLASS 5.0	27270104
ECLASS 5.1.4	27270104
ECLASS 6.0	27270104
ECLASS 6.2	27270104
ECLASS 7.0	27270104
ECLASS 8.0	27270104
ECLASS 8.1	27270104

ECLASS 9.0	27270104
ECLASS 10.0	27270104
ECLASS 11.0	27270104
ECLASS 12.0	27274301
ETIM 5.0	EC002544
ETIM 6.0	EC002544
ETIM 7.0	EC002544
ETIM 8.0	EC002544
UNSPSC 16.0901	39122230

Connection diagram Cd-470

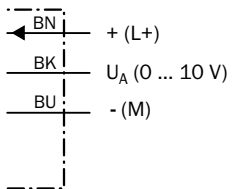

SpareCruX

Dimensional drawing Cable

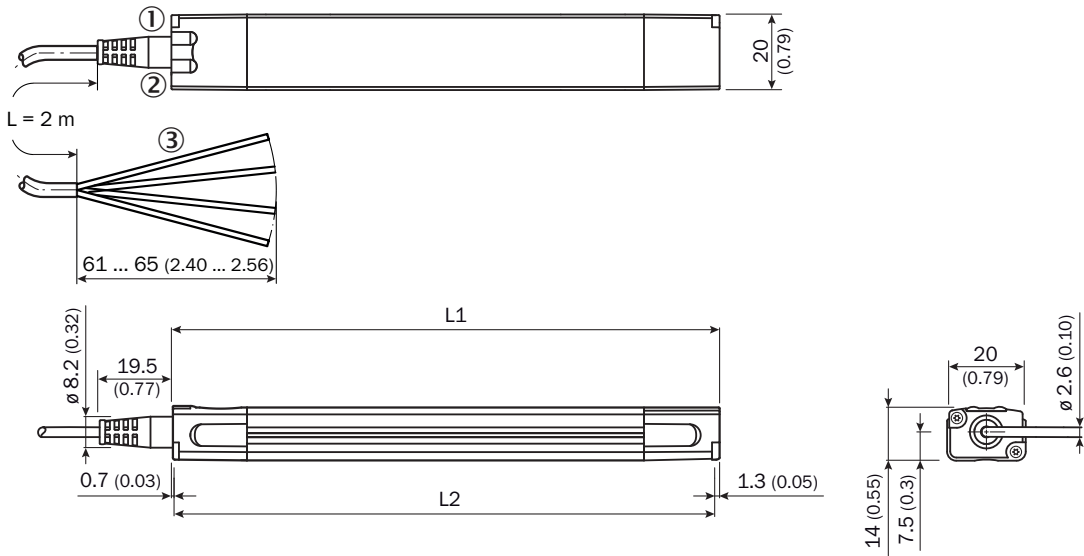

	Total length (L1) mm	Measuring range (L2) mm		Total length (L1) mm	Measuring range (L2) mm
MPA-107	109	107	MPA-575	577	575
MPA-143	145	143	MPA-611	613	611
MPA-179	181	179	MPA-647	649	647
MPA-215	217	215	MPA-683	685	683
MPA-251	253	251	MPA-719	721	719
MPA-287	289	287	MPA-755	757	755
MPA-323	325	323	MPA-791	793	791
MPA-359	361	359	MPA-827	829	827
MPA-395	397	395	MPA-863	865	863
MPA-431	433	431	MPA-899	901	899
MPA-467	469	467	MPA-935	937	935
MPA-503	505	503	MPA-971	973	971
MPA-539	541	539	MPA-1007	1,009	1,007





- Dimensions in mm (inch)
- ① Function signal indicator 1
 - ② Function signal indicator 2
 - ③ Connection

Recommended accessories

Other models and accessories → www.sick.com/MPA

	Brief description	Type	part no.
Mounting systems			
	<ul style="list-style-type: none"> Description: For round body cylinders with diameter up to 85 mm Material: Stainless steel Details: Stainless steel V2A Usable for: MPA-107 mm ... 359 mm (measuring range sensor), 2 (recommended number brackets), MPA-395 mm ... 647 mm (measuring range sensor), 3 (recommended number brackets), MPA-683 mm ... 935 mm (measuring range sensor), 4 (recommended number brackets), MPA-971 mm ... 1,007 mm (measuring range sensor), 5 (recommended number brackets) 	BEF-KHZR085MPA	2066626
	<ul style="list-style-type: none"> Description: For round body cylinders with diameter up to 135 mm Material: Stainless steel Details: Stainless steel V2A Usable for: MPA-107 mm ... 359 mm (measuring range sensor), 2 (recommended number brackets), MPA-395 mm ... 647 mm (measuring range sensor), 3 (recommended number brackets), MPA-683 mm ... 935 mm (measuring range sensor), 4 (recommended number brackets), MPA-971 mm ... 1,007 mm (measuring range sensor), 5 (recommended number brackets) 	BEF-KHZR135MPA	2066627
	<ul style="list-style-type: none"> Description: For round body cylinders with diameter up to 210 mm Material: Stainless steel Details: Stainless steel V2A Usable for: MPA-107 mm ... 359 mm (measuring range sensor), 2 (recommended number brackets), MPA-395 mm ... 647 mm (measuring range sensor), 3 (recommended number brackets), MPA-683 mm ... 935 mm (measuring range sensor), 4 (recommended number brackets), MPA-971 mm ... 1,007 mm (measuring range sensor), 5 (recommended number brackets) 	BEF-KHZR210MPA	2066628
	<ul style="list-style-type: none"> Description: For tie-rod cylinder (diameter tie-rod max. 18 mm) Material: Aluminum, stainless steel Details: Aluminum alloy (adapter), Stainless steel V2A (mounting-/fixing screw) Usable for: MPA-107 mm ... 251 mm (sensor measuring range), 2 (recommended number of brackets), MPA-287 mm ... 431 mm (measuring range sensor), 3 (recommended number mounting brackets), MPA-467 mm ... 647 mm (measuring range sensor), 4 (recommended number mounting brackets), MPA-683 mm ... 791 mm (measuring range sensor), 5 (recommended number mounting brackets), MPA-827 mm ... 1007 mm (measuring range sensor), 6 (recommended number mounting brackets) 	BEF-KHZPZ1MPA	2065578
	<ul style="list-style-type: none"> Description: For T-slot cylinders Material: Stainless steel, brass Details: Stainless steel V2A (bracket/mounting screw), Brass (fixing screw/sliding nut) Usable for: MPA-107 mm ... 251 mm (sensor measuring range), 2 (recommended number of brackets), MPA-287 mm ... 431 mm (measuring range sensor), 3 (recommended number mounting brackets), MPA-467 mm ... 647 mm (measuring range sensor), 4 (recommended number mounting brackets), MPA-683 mm ... 791 mm (measuring range sensor), 5 (recommended number mounting brackets), MPA-827 mm ... 1007 mm (measuring range sensor), 6 (recommended number mounting brackets) 	BEF-KHZT01MPA	2065575
	<ul style="list-style-type: none"> Description: Bracket for lateral mounting Material: Stainless steel, brass Details: Stainless steel V2A (bracket/mounting screw), Brass (fixing screw) Usable for: MPA-107 mm ... 251 mm (sensor measuring range), 2 (recommended number of brackets), MPA-287 mm ... 431 mm (measuring range sensor), 3 (recommended number mounting brackets), MPA-467 mm ... 647 mm (measuring range sensor), 4 (recommended number mounting brackets), MPA-683 mm ... 791 mm (measuring range sensor), 5 (recommended number mounting brackets), MPA-827 mm ... 1007 mm (measuring range sensor), 6 (recommended number mounting brackets) 	BEF-WNZ01MPA	2065577
	<ul style="list-style-type: none"> Description: Bracket for low mounting Material: Stainless steel, brass Details: Stainless steel V2A (bracket/mounting screw), Brass (fixing screw) Usable for: MPA-107 mm ... 251 mm (sensor measuring range), 2 (recommended number of brackets), MPA-287 mm ... 431 mm (measuring range sensor), 3 (recommended number mounting brackets), MPA-467 mm ... 647 mm (measuring range sensor), 4 (recommended number mounting brackets), MPA-683 mm ... 791 mm (measuring range sensor), 5 (recommended number mounting brackets), MPA-827 mm ... 1007 mm (measuring range sensor), 6 (recommended number mounting brackets) 	BEF-WNL01MPA	2065973
	<ul style="list-style-type: none"> Description: Sensor adapter DSBC-32 Dimensions (W x H x L): 10 mm x 16.9 mm x 43.4 mm Material: Stainless steel Details: Stainless steel V2A Usable for: MPA-107 mm ... 251 mm (sensor measuring range), 2 (recommended number of brackets), MPA-287 mm ... 431 mm (measuring range sensor), 3 (recommended number mounting brackets), MPA-467 mm ... 647 mm (measuring range sensor), 4 (recommended number mounting brackets), MPA-683 mm ... 791 mm (measuring range sensor), 5 (recommended number mounting brackets) 	BEF-KHZPF032MPA	2086744

	Brief description	Type	part no.
	<p>mounting brackets), MPA-827 mm ... 1007 mm (measuring range sensor), 6 (recommended number mounting brackets)</p> <ul style="list-style-type: none"> Description: Sensor adapter DSBC-40 Dimensions (W x H x L): 10 mm x 16.9 mm x 48.9 mm Material: Stainless steel Details: Stainless steel V2A Usable for: MPA-107 mm ... 251 mm (sensor measuring range), 2 (recommended number of brackets), MPA-287 mm ... 431 mm (measuring range sensor), 3 (recommended number mounting brackets), MPA-467 mm ... 647 mm (measuring range sensor), 4 (recommended number mounting brackets), MPA-683 mm ... 791 mm (measuring range sensor), 5 (recommended number mounting brackets), MPA-827 mm ... 1007 mm (measuring range sensor), 6 (recommended number mounting brackets) 	BEF-KHZPF040MPA	2086745
	<ul style="list-style-type: none"> Description: Sensor adapter DSBC-50 Dimensions (W x H x L): 10 mm x 16.9 mm x 51.7 mm Material: Stainless steel Details: Stainless steel V2A Usable for: MPA-107 mm ... 251 mm (sensor measuring range), 2 (recommended number of brackets), MPA-287 mm ... 431 mm (measuring range sensor), 3 (recommended number mounting brackets), MPA-467 mm ... 647 mm (measuring range sensor), 4 (recommended number mounting brackets), MPA-683 mm ... 791 mm (measuring range sensor), 5 (recommended number mounting brackets), MPA-827 mm ... 1007 mm (measuring range sensor), 6 (recommended number mounting brackets) 	BEF-KHZPF050MPA	2086746
	<ul style="list-style-type: none"> Description: Sensor adapter DSBC-63 Dimensions (W x H x L): 10 mm x 16.9 mm x 53.1 mm Material: Stainless steel Details: Stainless steel V2A Usable for: MPA-107 mm ... 251 mm (sensor measuring range), 2 (recommended number of brackets), MPA-287 mm ... 431 mm (measuring range sensor), 3 (recommended number mounting brackets), MPA-467 mm ... 647 mm (measuring range sensor), 4 (recommended number mounting brackets), MPA-683 mm ... 791 mm (measuring range sensor), 5 (recommended number mounting brackets), MPA-827 mm ... 1007 mm (measuring range sensor), 6 (recommended number mounting brackets) 	BEF-KHZPF063MPA	2086747
	<ul style="list-style-type: none"> Description: Sensor adapter DSBC-80 Dimensions (W x H x L): 10 mm x 16.9 mm x 58.4 mm Material: Stainless steel Details: Stainless steel V2A Usable for: MPA-107 mm ... 251 mm (sensor measuring range), 2 (recommended number of brackets), MPA-287 mm ... 431 mm (measuring range sensor), 3 (recommended number mounting brackets), MPA-467 mm ... 647 mm (measuring range sensor), 4 (recommended number mounting brackets), MPA-683 mm ... 791 mm (measuring range sensor), 5 (recommended number mounting brackets), MPA-827 mm ... 1007 mm (measuring range sensor), 6 (recommended number mounting brackets) 	BEF-KHZPF080MPA	2086748
	<ul style="list-style-type: none"> Description: Sensor adapter DSBC-100 Dimensions (W x H x L): 10 mm x 17 mm x 59.8 mm Material: Stainless steel Details: Stainless steel V2A Usable for: MPA-107 mm ... 251 mm (sensor measuring range), 2 (recommended number of brackets), MPA-287 mm ... 431 mm (measuring range sensor), 3 (recommended number mounting brackets), MPA-467 mm ... 647 mm (measuring range sensor), 4 (recommended number mounting brackets), MPA-683 mm ... 791 mm (measuring range sensor), 5 (recommended number mounting brackets), MPA-827 mm ... 1007 mm (measuring range sensor), 6 (recommended number mounting brackets) 	BEF-KHZPF100MPA	2086749
	<ul style="list-style-type: none"> Description: Sensor adapter DSBC-125 Dimensions (W x H x L): 10 mm x 22.5 mm x 63.7 mm Material: Stainless steel Details: Stainless steel V2A Usable for: MPA-107 mm ... 251 mm (sensor measuring range), 2 (recommended number of brackets), MPA-287 mm ... 431 mm (measuring range sensor), 3 (recommended number mounting brackets), MPA-467 mm ... 647 mm (measuring range sensor), 4 (recommended number mounting brackets), MPA-683 mm ... 791 mm (measuring range sensor), 5 (recommended number mounting brackets), MPA-827 mm ... 1007 mm (measuring range sensor), 6 (recommended number mounting brackets) 	BEF-KHZPF125MPA	2086750
	<ul style="list-style-type: none"> Description: Sensor adapter CP96-63 Dimensions (W x H x L): 10 mm x 11.7 mm x 12.6 mm Material: Stainless steel Details: Stainless steel V2A Usable for: MPA-107 mm ... 251 mm (sensor measuring range), 2 (recommended number of brackets), MPA-287 mm ... 431 mm (measuring range sensor), 3 (recommended number mounting brackets), MPA-467 mm ... 647 mm (measuring range sensor), 4 (recommended number mounting brackets), MPA-683 mm ... 791 mm (measuring range sensor), 5 (recommended number mounting brackets) 	BEF-KHZTS063MPA	2086756

	Brief description	Type	part no.
	<p>mounting brackets), MPA-827 mm ... 1007 mm (measuring range sensor), 6 (recommended number mounting brackets)</p> <ul style="list-style-type: none"> Description: Sensor adapter CP96-80 Dimensions (W x H x L): 10 mm x 13.7 mm x 14.8 mm Material: Stainless steel Details: Stainless steel V2A Usable for: MPA-107 mm ... 251 mm (sensor measuring range), 2 (recommended number of brackets), MPA-287 mm ... 431 mm (measuring range sensor), 3 (recommended number mounting brackets), MPA-467 mm ... 647 mm (measuring range sensor), 4 (recommended number mounting brackets), MPA-683 mm ... 791 mm (measuring range sensor), 5 (recommended number mounting brackets), MPA-827 mm ... 1007 mm (measuring range sensor), 6 (recommended number mounting brackets) 	BEF-KHZTS080MPA	2086757
	<ul style="list-style-type: none"> Description: Sensor adapter CP96-100 Dimensions (W x H x L): 10 mm x 12.9 mm x 14.8 mm Material: Stainless steel Details: Stainless steel V2A Usable for: MPA-107 mm ... 251 mm (sensor measuring range), 2 (recommended number of brackets), MPA-287 mm ... 431 mm (measuring range sensor), 3 (recommended number mounting brackets), MPA-467 mm ... 647 mm (measuring range sensor), 4 (recommended number mounting brackets), MPA-683 mm ... 791 mm (measuring range sensor), 5 (recommended number mounting brackets), MPA-827 mm ... 1007 mm (measuring range sensor), 6 (recommended number mounting brackets) 	BEF-KHZTS100MPA	2086758
	<ul style="list-style-type: none"> Description: Sensor adapter CP96-125 Dimensions (W x H x L): 10 mm x 12.2 mm x 14.6 mm Material: Stainless steel Details: Stainless steel V2A Usable for: MPA-107 mm ... 251 mm (sensor measuring range), 2 (recommended number of brackets), MPA-287 mm ... 431 mm (measuring range sensor), 3 (recommended number mounting brackets), MPA-467 mm ... 647 mm (measuring range sensor), 4 (recommended number mounting brackets), MPA-683 mm ... 791 mm (measuring range sensor), 5 (recommended number mounting brackets), MPA-827 mm ... 1007 mm (measuring range sensor), 6 (recommended number mounting brackets) 	BEF-KHZTS125MPA	2086759
	<ul style="list-style-type: none"> Description: Label Holder, 2.5 mm to 3.5 mm, 10 pcs. Material: Plastic Details: TPU Packing unit: 10 pieces 	LABEL HOLDER	2086019
<p>magnets</p>			
	<ul style="list-style-type: none"> Product segment: Magnets Product: Position magnets Description: Magnet with mounting hole for M3 countersunk screw, Ø 15.2 mm, height 6 mm Material: Hard ferrite 	Magnet	5327349

SICK AT A GLANCE

SICK is one of the leading manufacturers of intelligent sensors and sensor solutions for industrial applications. A unique range of products and services creates the perfect basis for controlling processes securely and efficiently, protecting individuals from accidents and preventing damage to the environment.

We have extensive experience in a wide range of industries and understand their processes and requirements. With intelligent sensors, we can deliver exactly what our customers need. In application centers in Europe, Asia and North America, system solutions are tested and optimized in accordance with customer specifications. All this makes us a reliable supplier and development partner.

Comprehensive services complete our offering: SICK LifeTime Services provide support throughout the machine life cycle and ensure safety and productivity.

For us, that is “Sensor Intelligence.”

WORLDWIDE PRESENCE:

Contacts and other locations – www.sick.com

SpareCruX