



# WTB9-3P2411P10

W9

PHOTOELECTRIC SENSORS

**SICK**  
Sensor Intelligence.



Illustration may differ

### Ordering information

Type	part no.
WTB9-3P2411P10	1116355

**Included in delivery:** BEF-KHS-ISG6 (1)

Other models and accessories → [www.sick.com/W9](http://www.sick.com/W9)

### Detailed technical data

#### Features

<b>Functional principle</b>	Photoelectric proximity sensor
<b>Functional principle detail</b>	Background suppression
<b>Dimensions (W x H x D)</b>	12.2 mm x 52.2 mm x 23.6 mm
<b>Housing design (light emission)</b>	Rectangular
<b>Mounting hole</b>	M3
<b>Sensing range max.</b>	20 mm ... 800 mm <sup>1)</sup>
<b>Sensing range</b>	20 mm ... 400 mm <sup>2)</sup>
<b>Type of light</b>	Infrared light
<b>Light source</b>	LED <sup>3)</sup>
<b>Light spot size (distance)</b>	Ø 40 mm (400 mm)
<b>Wave length</b>	850 nm
<b>Adjustment</b>	Potentiometer, 5 turns
<b>Special features</b>	Pre-mounted on BEF-KHS-ISG6, 2075080

<sup>1)</sup> Object with 90% remission (based on standard white, DIN 5033).

<sup>2)</sup> Object with 6% remission (based on standard white, DIN 5033).

<sup>3)</sup> Average service life: 100,000 h at T<sub>J</sub> = +25 °C.

#### Mechanics/electronics

<b>Supply voltage U<sub>B</sub></b>	10 V DC ... 30 V DC <sup>1)</sup>
-------------------------------------	-----------------------------------

<sup>1)</sup> Limit values when operated in short-circuit protected network: max. 8 A.

<sup>2)</sup> May not fall below or exceed U<sub>V</sub> tolerances.

<sup>3)</sup> Without load.

<sup>4)</sup> Q = light switching.

<sup>5)</sup> At and above T<sub>u</sub> 50 °C, a max. load current of I<sub>max</sub> = 50 mA is permitted.

<sup>6)</sup> Signal transit time with resistive load.

<sup>7)</sup> With light/dark ratio 1:1.

<sup>8)</sup> A = V<sub>S</sub> connections reverse-polarity protected.

<sup>9)</sup> B = inputs and output reverse-polarity protected.

<sup>10)</sup> C = interference suppression.

<b>Ripple</b>	< 5 V <sub>pp</sub> <sup>2)</sup>
<b>Current consumption</b>	30 mA <sup>3)</sup>
<b>Switching output</b>	PNP <sup>4)</sup>
<b>Output function</b>	Complementary
<b>Switching mode</b>	Light/dark switching <sup>4)</sup>
<b>Output current I<sub>max.</sub></b>	≤ 100 mA <sup>5)</sup>
<b>Response time</b>	< 2.5 ms <sup>6)</sup>
<b>Switching frequency</b>	200 Hz <sup>7)</sup>
<b>Connection type</b>	Male connector M12, 4-pin
<b>Circuit protection</b>	A <sup>8)</sup> B <sup>9)</sup> C <sup>10)</sup>
<b>Protection class</b>	III
<b>Weight</b>	13 g
<b>Special device</b>	✓
<b>Housing material</b>	Plastic, VISTAL®
<b>Optics material</b>	Plastic, PMMA
<b>Enclosure rating</b>	IP66 IP67 IP69K
<b>Items supplied</b>	Mounting system BEF-KHS-ISG6 (premounted)
<b>Ambient operating temperature</b>	-40 °C ... +60 °C
<b>Ambient temperature, storage</b>	-40 °C ... +75 °C
<b>UL File No.</b>	NRKH.E181493

1) Limit values when operated in short-circuit protected network: max. 8 A.

2) May not fall below or exceed U<sub>y</sub> tolerances.

3) Without load.

4) Q = light switching.

5) At and above T<sub>u</sub> 50 °C, a max. load current of I<sub>max.</sub> = 50 mA is permitted.

6) Signal transit time with resistive load.

7) With light/dark ratio 1:1.

8) A = V<sub>S</sub> connections reverse-polarity protected.

9) B = inputs and output reverse-polarity protected.

10) C = interference suppression.

### Safety-related parameters

<b>MTTF<sub>D</sub></b>	896 years
<b>DC<sub>avg</sub></b>	0 %
<b>T<sub>M</sub> (mission time)</b>	20 years

### Classifications

<b>ECLASS 5.0</b>	27270904
<b>ECLASS 5.1.4</b>	27270904
<b>ECLASS 6.0</b>	27270904
<b>ECLASS 6.2</b>	27270904

<b>ECLASS 7.0</b>	27270904
<b>ECLASS 8.0</b>	27270904
<b>ECLASS 8.1</b>	27270904
<b>ECLASS 9.0</b>	27270904
<b>ECLASS 10.0</b>	27270904
<b>ECLASS 11.0</b>	27270904
<b>ECLASS 12.0</b>	27270903
<b>ETIM 5.0</b>	EC002719
<b>ETIM 6.0</b>	EC002719
<b>ETIM 7.0</b>	EC002719
<b>ETIM 8.0</b>	EC002719
<b>UNSPSC 16.0901</b>	39121528

### Adjustments possible Potentiometer



- ④ LED indicator yellow: Status of received light beam
- ⑤ LED indicator green: power on
- ⑨ Adjustment of sensing range

### Connection type

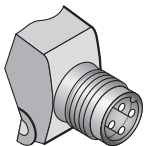

### Connection diagram Cd-084

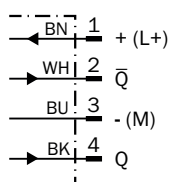

**Characteristic curve WTB9-3, infrared light, 800 mm**

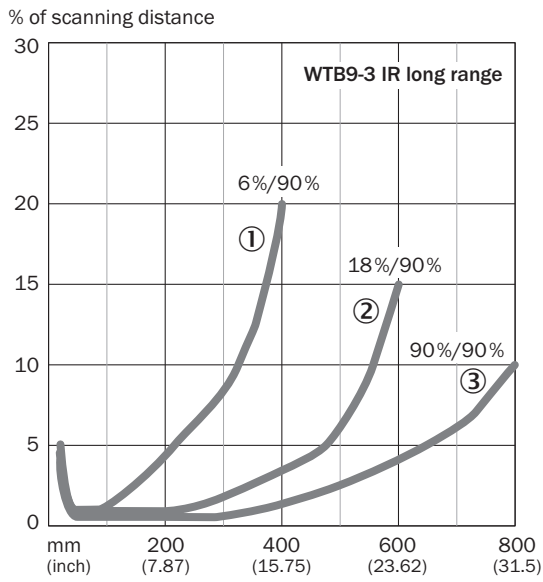

- ① Sensing range on black, 6% remission factor
- ② Sensing range on gray, 18% remission factor
- ③ Sensing range on white, 90% remission factor

**Light spot size WTB9-3, infrared light, 800 mm**

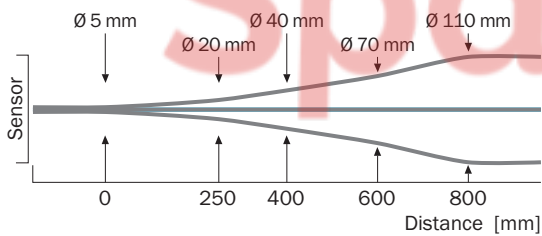

**Sensing range diagram WTB9-3, infrared light, 800 mm**

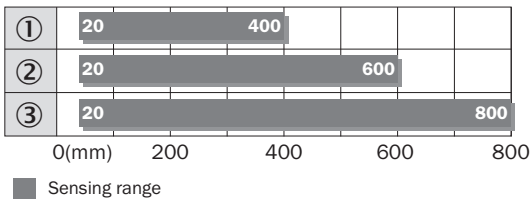

- ① Sensing range on black, 6% remission factor
- ② Sensing range on gray, 18% remission factor
- ③ Sensing range on white, 90% remission factor

Dimensional drawing WT9-3

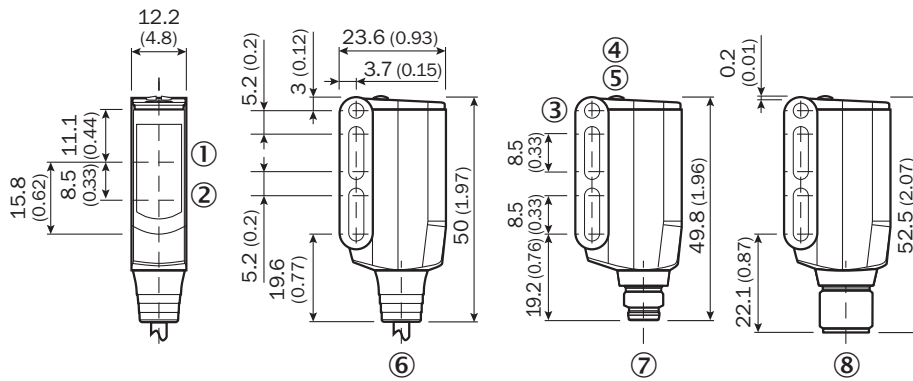







Dimensions in mm (inch)

- ① Center of optical axis, receiver
- ② Center of optical axis, sender
- ③ Mounting hole M3 (Ø 3.1 mm)
- ④ LED indicator yellow: Status of received light beam
- ⑤ LED indicator green: power on
- ⑥ Connection cable 2 m
- ⑦ male connector M8, 4-pin
- ⑧ male connector M12, 4-pin

Recommended accessories

Other models and accessories → [www.sick.com/W9](http://www.sick.com/W9)

	Brief description	Type	part no.
Mounting systems			
	<ul style="list-style-type: none"> <li>• <b>Description:</b> Plate N08 for universal clamp bracket</li> <li>• <b>Material:</b> Steel, zinc diecast</li> <li>• <b>Details:</b> Zinc plated steel (sheet), Zinc die cast (clamping bracket)</li> <li>• <b>Items supplied:</b> Universal clamp (5322626), mounting hardware</li> <li>• <b>Usable for:</b> W100, W150, W4S, W4F, W8, W9-3, W8G, W8 Laser, W8 Inox, G6, W100 Laser, W100-2, W10, G6 Inox, RAY10, W4SLG-3, W9, GR18, MultiPulse, Reflex Array, MultiLine, LUT3, KT5, KT8, KT10, CS8</li> </ul>	BEF-KHS-N08	2051607
	<ul style="list-style-type: none"> <li>• <b>Description:</b> Mounting bracket</li> <li>• <b>Material:</b> Steel</li> <li>• <b>Details:</b> Steel, zinc coated</li> <li>• <b>Items supplied:</b> Mounting hardware included</li> <li>• <b>Suitable for:</b> W9-3</li> </ul>	BEF-WN-W9-2	2022855
	<ul style="list-style-type: none"> <li>• <b>Description:</b> Plate N11N for universal clamp bracket</li> <li>• <b>Material:</b> Stainless steel</li> <li>• <b>Details:</b> Stainless steel 1.4571 (sheet), Stainless steel 1.4408 (clamp)</li> <li>• <b>Items supplied:</b> Universal clamp (5322627), mounting hardware</li> <li>• <b>Usable for:</b> DeltaPac, Glare, WTD20E</li> </ul>	BEF-KHS-N11N	2071081

	Brief description	Type	part no.
connectors and cables			
	<ul style="list-style-type: none"> <li>• <b>Connection type head A:</b> Female connector, M12, 4-pin, straight, A-coded</li> <li>• <b>Connection type head B:</b> Flying leads</li> <li>• <b>Signal type:</b> Sensor/actuator cable</li> <li>• <b>Cable:</b> 5 m, 4-wire, PVC</li> <li>• <b>Description:</b> Sensor/actuator cable, unshielded</li> <li>• <b>Application:</b> Zones with chemicals, Uncontaminated zones</li> </ul>	YF2A14-050VB3XLEAX	2096235
	<ul style="list-style-type: none"> <li>• <b>Connection type head A:</b> Male connector, M12, 4-pin, straight, A-coded</li> <li>• <b>Description:</b> Unshielded</li> <li>• <b>Connection systems:</b> Screw-type terminals</li> <li>• <b>Permitted cross-section:</b> ≤ 0.75 mm<sup>2</sup></li> </ul>	STE-1204-G	6009932
	<ul style="list-style-type: none"> <li>• <b>Connection type head A:</b> Female connector, M12, 4-pin, straight, A-coded</li> <li>• <b>Connection type head B:</b> Flying leads</li> <li>• <b>Signal type:</b> Sensor/actuator cable</li> <li>• <b>Cable:</b> 5 m, 4-wire, PUR, halogen-free</li> <li>• <b>Description:</b> Sensor/actuator cable, unshielded</li> <li>• <b>Application:</b> Uncontaminated zones, Zones with oils and lubricants, Robot, Drag chain operation</li> </ul>	YF2A14-050UB3XLEAX	2095608



## SICK AT A GLANCE

SICK is one of the leading manufacturers of intelligent sensors and sensor solutions for industrial applications. A unique range of products and services creates the perfect basis for controlling processes securely and efficiently, protecting individuals from accidents and preventing damage to the environment.

We have extensive experience in a wide range of industries and understand their processes and requirements. With intelligent sensors, we can deliver exactly what our customers need. In application centers in Europe, Asia and North America, system solutions are tested and optimized in accordance with customer specifications. All this makes us a reliable supplier and development partner.

Comprehensive services complete our offering: SICK LifeTime Services provide support throughout the machine life cycle and ensure safety and productivity.

For us, that is “Sensor Intelligence.”

### WORLDWIDE PRESENCE:

Contacts and other locations – [www.sick.com](http://www.sick.com)

SpareCruX