

WTM10L-241611D0A00ZVZZZZZZZZZZ1

W10

PHOTOELECTRIC SENSORS

SICK
Sensor Intelligence.



Illustration may differ



Ordering information

Type	part no.
WTM10L-241611D0A00ZVZZZZZZZZ1	1133547

Other models and accessories → www.sick.com/W10

Detailed technical data

Features

Functional principle	Photoelectric proximity sensor
Functional principle detail	Background suppression, Foreground suppression, MultiMode
MultiMode	Background suppression Foreground suppression 1-point teach-in 2-point teach-in Manual teach-in ApplicationSelect (Mode 1 - Speed, Mode 2 - Standard, Mode 3 - Precision) Measurement
Sensing range	
Sensing range min.	25 mm (Mode 1 - Speed) 25 mm (Mode 2 - Standard) 25 mm (Mode 3 - Precision)
Sensing range max.	300 mm (Mode 1 - Speed) 500 mm (Mode 2 - Standard) 700 mm (Mode 3 - Precision)
Adjustable switching threshold for background suppression	25 mm ... 300 mm (Mode 1 - Speed) 25 mm ... 500 mm (Mode 2 - Standard) 25 mm ... 700 mm (Mode 3 - Precision)

¹⁾ 90% remission factor.

²⁾ Equivalent to 1 σ .

³⁾ Observe min. warm-up time of 15 minutes.

⁴⁾ Do not intentionally look into the laser beam. Never point the laser beam at people's eyes.

Reference object	Object with 90% remission factor (complies with standard white according to DIN 5033)
Minimum distance between set sensing range and background (black 6% / white 90%)	6 mm, at a distance of 250 mm (Mode 1 - Speed)
	8 mm, at a distance of 400 mm (Mode 2 - Standard)
	10 mm, at a distance of 500 mm (Mode 3 - Precision)
Recommended sensing range for the best performance	50 mm ... 250 mm (Mode 1 - Speed)
	50 mm ... 400 mm (Mode 2 - Standard)
	50 mm ... 500 mm (Mode 3 - Precision)
Distance value	
Measuring range	25 mm ... 700 mm
Resolution	1 mm
Repeatability	< 0,5 % ^{1) 2) 3)}
Accuracy	< 4 % ¹⁾
Distance value output	Via IO-Link + display
Emitted beam	
Light source	Laser
Type of light	Visible red light
Shape of light spot	Point-shaped
Light spot size (distance)	Ø 0.4 mm (250 mm)
Maximum dispersion of the emitted beam around the standardized transmission axis (squint angle)	< +/- 1.0° (at Ta = +23 °C)
Key laser figures	
Normative reference	IEC 60825-1 / CDRH 21 CFR 1040.10 & 1040.11, EN 60825-1:2014, IEC 60825-1:2014 (except for tolerances according to Laser Notice No. 56 dated May 8, 2019)
Laser class	1 ⁴⁾
Wave length	655 nm
Pulse duration	4 µs
Maximum pulse power	< 2.5 mW
Average service life	50,000 h at T _U = +25 °C
Smallest detectable object (MDO) typ.	
	0.6 mm (at a distance of 250 mm)
	Object with 90% remission factor (complies with standard white according to DIN 5033)
Adjustment	
Touch display	For setting the sensing range and configuring the sensor parameters
IO-Link	For configuring the sensor parameters and Smart Task functions
Display	
Display	Display of mode, display of output states, display of the distance value, display of the set value
LED green	Operating indicator Static on: power on

¹⁾ 90% remission factor.

²⁾ Equivalent to 1 σ.

³⁾ Observe min. warm-up time of 15 minutes.

⁴⁾ Do not intentionally look into the laser beam. Never point the laser beam at people's eyes.

	Flashing: IO-Link mode
LED yellow	Status of received light beam Static on: object present Static off: object not present
Special features	MultiMode
Special applications	Detecting small objects, Detection of objects moving at high speeds, Detecting flat objects, Detecting uneven, shiny objects, Detection of poorly remitting and tilted objects

¹⁾ 90% remission factor.

²⁾ Equivalent to 1 σ .

³⁾ Observe min. warm-up time of 15 minutes.

⁴⁾ Do not intentionally look into the laser beam. Never point the laser beam at people's eyes.

Safety-related parameters

MTTF_D	473 years
DC_{avg}	0 %
T_M (mission time)	10 years

Communication interface

IO-Link	✓, IO-Link V1.1
Data transmission rate	COM2 (38,4 kBaud)
Cycle time	3.4 ms
Process data length	32 Bit
Process data structure	Bit 0 = switching signal Q _{L1} Bit 1 = switching signal Q _{L2} Bit 2 ... 5 = Qint.1 ... Qint.4 Bit 6 = Operating status of the sensor Bit 7 ... 15 = Empty Bit 16 ... 31 = Distance to object
VendorID	26
DeviceID HEX	0x80032E
DeviceID DEC	8389422
Compatible master port type	A
SIO mode support	Yes

Electronics

Supply voltage U_B	10 V DC ... 30 V DC ¹⁾
Ripple	≤ 5 V _{pp}
Usage category	DC-12 (According to EN 60947-5-2) DC-13 (According to EN 60947-5-2)
Current consumption	≤ 25 mA, without load. At U _B = 24 V
Protection class	III
Digital output	
Number	2
Type	Push-pull: PNP/NPN, Individually adjustable

¹⁾ Limit values.

²⁾ Signal transit time with resistive load in switching mode.

³⁾ With light/dark ratio 1:1.

Switching mode	Light/dark switching
Output characteristic	Individually adjustable
Signal voltage PNP HIGH/LOW	Approx. $U_B - 2.0 \text{ V} / 0 \text{ V}$
Signal voltage NPN HIGH/LOW	Approx. $U_B - 1.0 \text{ V} / < 2.5 \text{ V}$
Output current I_{\max}	$\leq 100 \text{ mA}$
Circuit protection outputs	Reverse polarity protected
	Overcurrent protected
	Short-circuit protected
Response time	1.8 ms (Mode 1 - Speed) ²⁾
	5 ms (Mode 2 - Standard) ²⁾
	15 ms (Mode 3 - Precision) ²⁾
Repeatability (response time)	< 0,5 %
Switching frequency	275 Hz (Mode 1 - Speed) ³⁾
	100 Hz (Mode 2 - Standard) ³⁾
	30 Hz (Mode 3 - Precision) ³⁾
Pin/Wire assignment	
BN 1	+ (L+)
WH 2	\bar{Q}_{L1}/MF
	Digital output, dark switching, object present → output \bar{Q}_{L1} LOW (background suppression)
	Digital output, light switching, object present → output Q_{L1} LOW (foreground suppression)
	The pin 2 function of the sensor can be configured
	Additional possible settings via IO-Link
BU 3	- (M)
BK 4	Q_{L1}/C
	Digital output, light switching, object present → output Q_{L1} HIGH (background suppression)
	Digital output, dark switching, object present → output \bar{Q}_{L1} HIGH (foreground suppression)
	IO-Link communication C
	The pin 4 function of the sensor can be configured
	Additional possible settings via IO-Link

¹⁾ Limit values.

²⁾ Signal transit time with resistive load in switching mode.

³⁾ With light/dark ratio 1:1.

Mechanics

Housing	Rectangular
Dimensions (W x H x D)	18 mm x 57 mm x 42.2 mm
Connection	Male connector M12, 4-pin
Material	
Housing	Metal, Stainless steel V4A (1.4404, 316L)
Front screen	Plastic, PMMA
Display cover	Plastic, PMMA
LED	Plastic, ABS
Male connector	Metal, Stainless steel V4A (1.4404, 316L)
Weight	Approx. 100 g

Maximum tightening torque of the fixing screws	0.56 Nm
---	---------

Ambient data

Enclosure rating	IP67 (EN 60529) IP69 (Replaces IP69K with ISO 20653: 2013-03)
Ambient operating temperature	-10 °C ... +55 °C
Ambient temperature, storage	-40 °C ... +75 °C
Warm-up time	Observe min. warm-up time of 15 minutes ¹⁾
Typ. Ambient light immunity	Artificial light: ≤ 10,000 lx Sunlight: ≤ 10,000 lx
Air humidity	35 % ... 95 %, relative humidity (no condensation)
Electromagnetic compatibility (EMC)	EN 60947-5-2, The sensor complies with the Radio Safety Requirements (EMC) for the industrial sector (Radio Safety Class A). It may cause radio interference if used in a residential area.

¹⁾ During the device warm-up phase, the measured values are subject to increased scatter (temperature drift).

Smart Task

Smart Task name	Base logics
Logic function	Direct AND OR Window Hysteresis
Timer function	Deactivated Switch-on delay Off delay ON and OFF delay Impulse (one shot)
Inverter	Yes
Switching signal	
Switching signal Q_{L1}	Switching output
Switching signal \bar{Q}_{L1}	Switching output

Diagnosis

Device temperature	
Measuring range	Very cold, cold, moderate, warm, hot
Device status	Yes
Detailed device status	Yes
Operating hour counter	Yes
Operating hours counter with reset function	Yes

Certificates

EU declaration of conformity	✓
UK declaration of conformity	✓
ACMA declaration of conformity	✓
Moroccan declaration of conformity	✓
China RoHS	✓
cULus certificate	✓
IO-Link certificate	✓

Laser safety (IEC 60825-1) certificate	✓
Information according to Art. 3 of Data Act (Regulation EU 2023/2854)	✓

Classifications

ECLASS 5.0	27270904
ECLASS 5.1.4	27270904
ECLASS 6.0	27270904
ECLASS 6.2	27270904
ECLASS 7.0	27270904
ECLASS 8.0	27270904
ECLASS 8.1	27270904
ECLASS 9.0	27270904
ECLASS 10.0	27270904
ECLASS 11.0	27270904
ECLASS 12.0	27270903
ETIM 5.0	EC002719
ETIM 6.0	EC002719
ETIM 7.0	EC002719
ETIM 8.0	EC002719
UNSPSC 16.0901	39121528

SpareCruX

Dimensional drawing

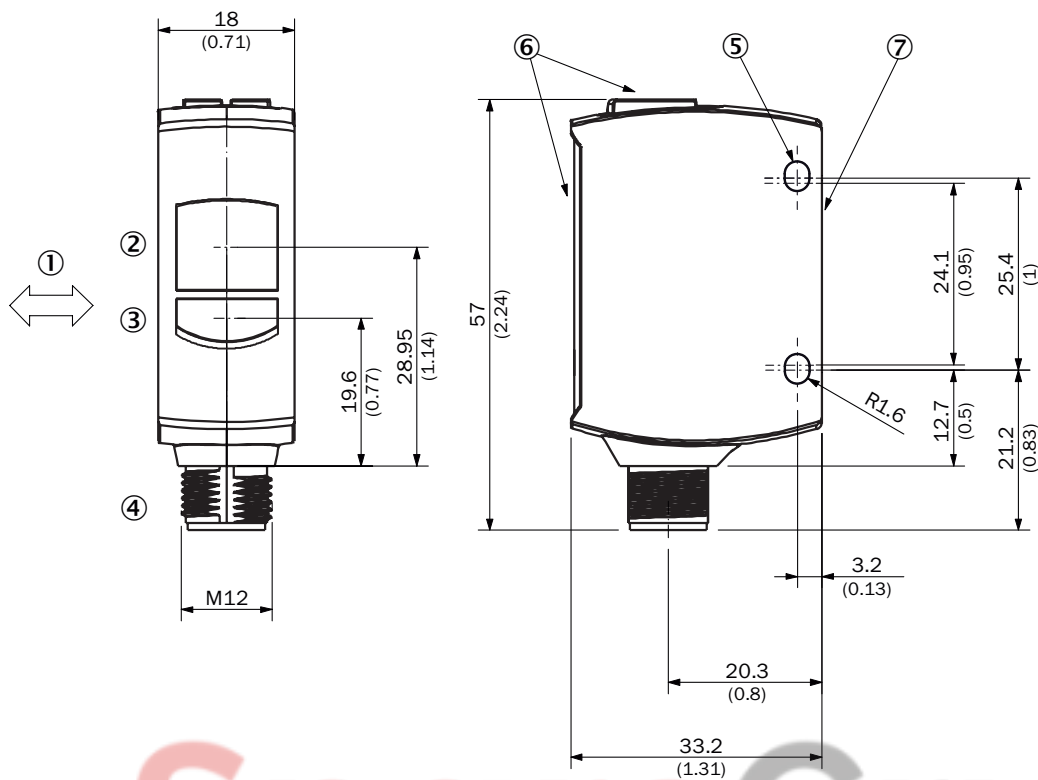

Dimensions in mm (inch)

- ① Standard direction of the material being detected
- ② Center of optical axis, receiver
- ③ Center of optical axis, sender
- ④ Connection
- ⑤ Mounting hole, \varnothing 3.2 mm
- ⑥ display and adjustment elements
- ⑦ zero point measurement range

display and adjustment elements

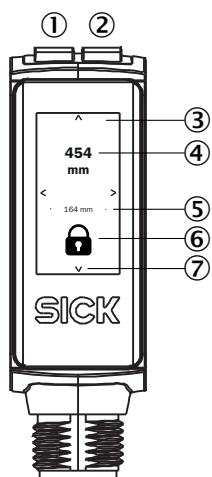

- ① LED green
- ② LED yellow

- ③ touch display
- ④ Current distance
- ⑤ Distance of last good teach-in
- ⑥ Lock/unlock status indicator
- ⑦ Display navigation arrows

Connection type M12 male connector, 4-pin

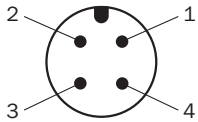

Connection diagram Cd-561 (background suppression)

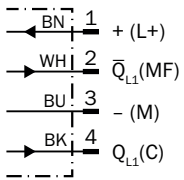

Connection diagram Cd-562 (foreground suppression)

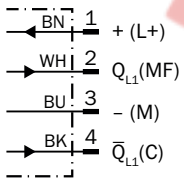

Truth table Push-pull: PNP/NPN - dark switching \bar{Q} (background suppression)

	Dark switching \bar{Q} (normally closed (upper switch), normally open (lower switch))	
	Object not present → Output HIGH	Object present → Output LOW
Light receive	✗	✓
Light receive indicator	✗	☀
Load resistance to L+	✗	⚡
Load resistance to M	⚡	✗

Truth table Push-pull: PNP/NPN - light switching Q (background suppression)

	Light switching Q (normally open (upper switch), normally closed (lower switch))	
	Object not present → Output LOW	Object present → Output HIGH
Light receive	✗	✓
Light receive indicator	✗	☀
Load resistance to L+	⚡	✗
Load resistance to M	✗	⚡

Truth table Push-pull: PNP/NPN - dark switching \bar{Q} (foreground suppression)

	Dark switching \bar{Q} (normally open (upper switch), normally closed (lower switch))	
	Object not present → Output LOW	Object present → Output HIGH
Light receive	✓	✗
Light receive indicator	☀	☀
Load resistance to L+	⚡	✗
Load resistance to M	✗	⚡

Truth table Push-pull: PNP/NPN - light switching Q (foreground suppression)

	Light switching Q (normally closed (upper switch), normally open (lower switch))	
	Object not present → Output HIGH	Object present → Output LOW
Light receive	✓	✗
Light receive indicator	☀	☀
Load resistance to L+	✗	⚡
Load resistance to M	⚡	✗

Characteristic curve Background suppression

Minimum distance in mm (y) between the set sensing range and white background (90 % remission)

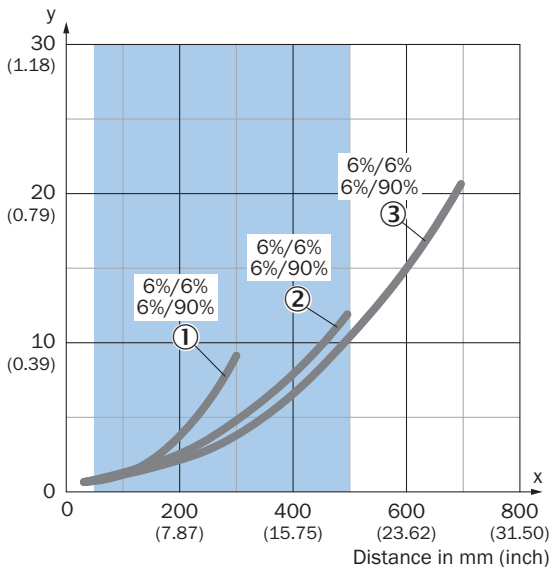

Example:
Safe suppression of the background

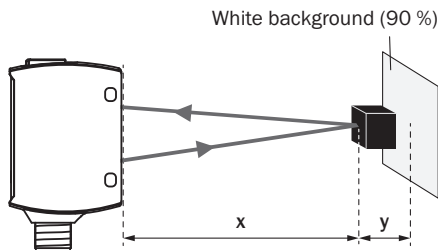

Black object (6 % remission)
Set sensing range $x = 500$ mm
Needed minimum distance to white background $y = 10$ mm

Recommended sensing range for the best performance

- ① Black object, 6% remission factor, Mode 1 - Speed
- ② Black object, 6% remission factor, Mode 2 - Standard
- ③ Black object, 6% remission factor, Mode 3 - Precision



Characteristic curve Foreground suppression

Minimum object height in mm (inch)

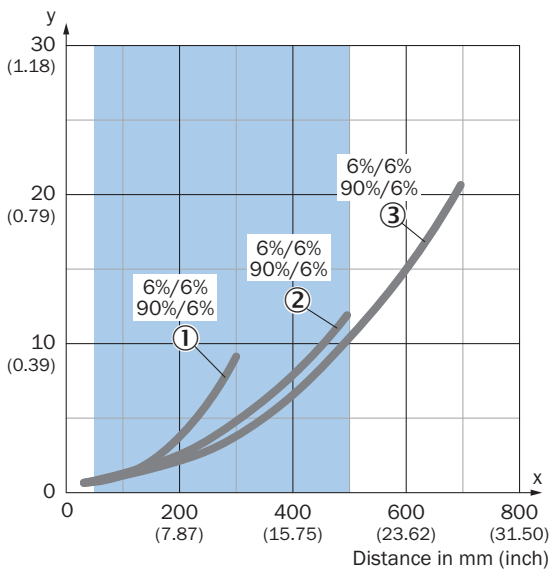

Example:
Reliable detection of the object

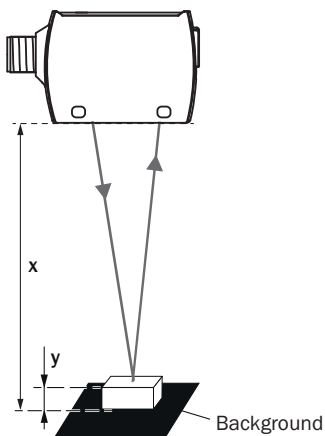

Black background (6 % remission factor)
Distance of sensor to background $x = 500$ mm
Required minimum object height $y = 10$ mm
For all objects regardless of their colors

Recommended sensing range for the best performance

- ① Black object, 6% remission factor, Mode 1 - Speed
- ② Black object, 6% remission factor, Mode 2 - Standard

③ Black object, 6% remission factor, Mode 3 - Precision

Light spot size Background suppression

Dimensions in mm (inch)

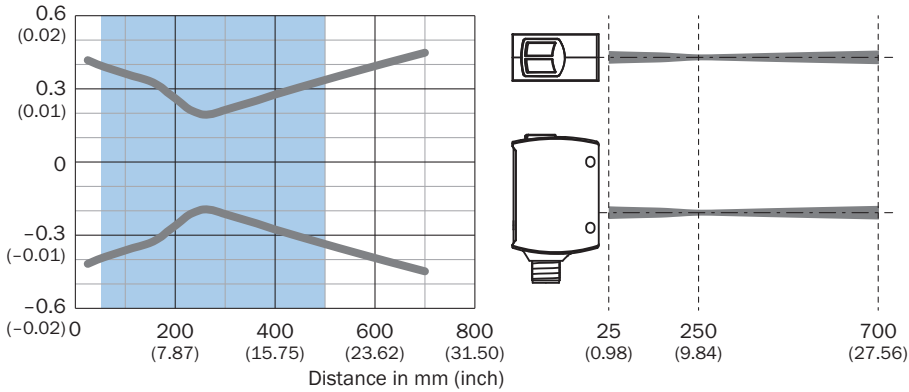

Recommended sensing range for the best performance

Sensing range diagram Background suppression

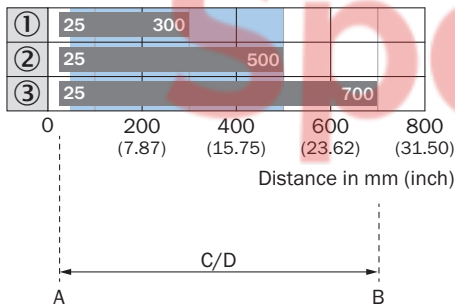











Recommended sensing range for the best performance

①	25	300
②	25	500
③	25	700
A	Sensing range min. in mm	
B	Sensing range max. in mm	
C	Field of view	
D	Adjustable switching threshold for background suppression	

Recommended accessories

Other models and accessories → www.sick.com/W10

	Brief description	Type	part no.
network devices			
		SIG350-0004AP100	6076871
		SIG300-0A0GAA100	1131014
		SIG300-0A04AA100	1131011
		SIG300-0A05AA100	1131012
		SIG300-0A06AA100	1131013
Mounting systems			
	<ul style="list-style-type: none"> • Description: Plate N08 for universal clamp bracket • Material: Steel, zinc diecast • Details: Zinc plated steel (sheet), Zinc die cast (clamping bracket) • Items supplied: Universal clamp (5322626), mounting hardware • Usable for: W100, W150, W4S, W4F, W8, W9-3, W8G, W8 Laser, W8 Inox, G6, W100 Laser, W100-2, W10, G6 Inox, RAY10, W4SLG-3, W9, GR18, MultiPulse, Reflex Array, MultiLine, LUT3, KT5, KT8, KT10, CS8 	BEF-KHS-N08	2051607

	Brief description	Type	part no.
connectors and cables			
	<ul style="list-style-type: none"> • Connection type head A: Female connector, M12, 4-pin, straight, A-coded • Connection type head B: Flying leads • Signal type: Sensor/actuator cable • Cable: 5 m, 4-wire, PUR, halogen-free • Description: Sensor/actuator cable, unshielded • Application: Uncontaminated zones, Zones with oils and lubricants, Robot, Drag chain operation 	YF2A14-050UB3XLEAX	2095608
	<ul style="list-style-type: none"> • Connection type head A: Female connector, M12, 4-pin, straight, A-coded • Connection type head B: Flying leads • Signal type: Sensor/actuator cable • Cable: 5 m, 4-wire, PVC • Description: Sensor/actuator cable, unshielded • Application: Zones with chemicals, Uncontaminated zones 	YF2A14-050VB3XLEAX	2096235
	<ul style="list-style-type: none"> • Connection type head A: Female connector, M12, 4-pin, straight • Connection type head B: Flying leads • Signal type: Sensor/actuator cable • Cable: 5 m, 4-wire, PVC • Description: Sensor/actuator cable, unshielded • Connection systems: Flying leads • Note: This product is generally resistant to chemical cleaning agents (see ECOLAB). Please do not use cleaning agents of any other Kind., Not resistant against lactic acid & hydrogen peroxide (H2O2) • Application: Hygienic and washdown zones 	DOL-1204-G05MNI	6052615
	<ul style="list-style-type: none"> • Connection type head A: Female connector, M12, 4-pin, straight • Connection type head B: Flying leads • Signal type: Sensor/actuator cable • Cable: 5 m, 4-wire, PP • Description: Sensor/actuator cable, unshielded • Connection systems: Flying leads • Note: This product is generally resistant to chemical cleaning agents (see ECOLAB) and other chemical compounds such as H2O2 and CH2O2. Before permanent installation is carried out, the material's resistance to the cleaning agent being used must be checked., Resistant against lactic acid & hydrogen peroxide (H2O2) • Application: Hygienic and washdown zones, Drag chain operation 	DOL-1204-G05MRN	6058476

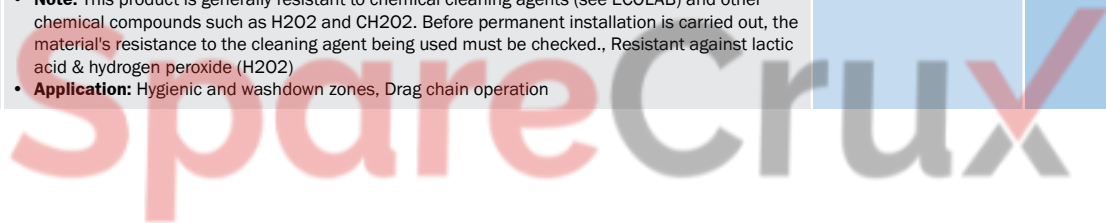

SICK AT A GLANCE

SICK is one of the leading manufacturers of intelligent sensors and sensor solutions for industrial applications. A unique range of products and services creates the perfect basis for controlling processes securely and efficiently, protecting individuals from accidents and preventing damage to the environment.

We have extensive experience in a wide range of industries and understand their processes and requirements. With intelligent sensors, we can deliver exactly what our customers need. In application centers in Europe, Asia and North America, system solutions are tested and optimized in accordance with customer specifications. All this makes us a reliable supplier and development partner.

Comprehensive services complete our offering: SICK LifeTime Services provide support throughout the machine life cycle and ensure safety and productivity.

For us, that is “Sensor Intelligence.”

WORLDWIDE PRESENCE:

Contacts and other locations – www.sick.com

SpareCruX