

SpareCruX



# SAS4-F012P3PS2W0B

SLG

**AUTOMATION LIGHT GRIDS**

**SICK**  
Sensor Intelligence.



### Ordering information

Type	part no.
SAS4-F012P3PS2W0B	1214346

Other models and accessories → [www.sick.com/SLG](http://www.sick.com/SLG)

Illustration may differ



### Detailed technical data

#### Features

<b>Sensor principle</b>	Sender/receiver
<b>Minimum detectable object (MDO)</b>	Cross beam, 25 mm <sup>1)</sup>
<b>Beam separation</b>	40 mm
<b>Optical light exit</b>	Flat
<b>Number of beams</b>	4
<b>Detection height</b>	120 mm
<b>Parameterization</b>	None
<b>Cross beam/parallel beam</b>	Cross beam active
<b>Output 1</b>	Output 1 inactive, if light beam interrupted
<b>Muting function</b>	Muting function deactivated
<b>Automatic teach</b>	Automatic teach inactive
<b>Alignment aid</b>	With alignment aid

<sup>1)</sup> 25 mm MDO limited detection area.

#### Mechanics/electronics

<b>Light source</b>	Infrared light
<b>Wave length</b>	950 nm
<b>Supply voltage V<sub>s</sub></b>	DC24 V, ± 20 %
<b>Power consumption receiver</b>	≤ 70 mA
<b>Output current I<sub>max.</sub></b>	100 mA
<b>Output load, capacitive</b>	100 nF
<b>Output load, Inductive</b>	1 H
<b>Initialization time</b>	1 s
<b>Switching output</b>	PNP

<b>Inputs</b>	Teach-in input (receiver) Test input (sender) HIGH = 10 V ... 30 V / LOW = < 5 V
<b>Dimensions (W x H x D)</b>	36.5 mm x 192.4 mm x 12.4 mm
<b>Connection type</b>	Cable with M8 male connector, 4-pin
<b>Housing material</b>	PMMA
<b>Display</b>	LED
<b>Synchronization</b>	Optical
<b>Enclosure rating</b>	IP65
<b>Circuit protection</b>	U <sub>V</sub> connections, reverse polarity protected Output Q short-circuit protected Interference pulse suppression
<b>Protection class</b>	III
<b>Weight</b>	20 g
<b>Pulse frequency</b>	500 kHz
<b>Aluminum stabilizer</b>	With stabilizer

### Performance

<b>Maximum range</b>	4 m <sup>1)</sup>
<b>Minimum range</b>	Cross beam: ≥ 0.3 m <sup>2)</sup>
<b>Operating range</b>	3 m
<b>Response time</b>	Cross beam, 57 ms

<sup>1)</sup> No reserve for environmental issue and deterioration of the diode.

<sup>2)</sup> Aperture ± 10°.

### Ambient data

<b>Shock resistance</b>	10 g / DIN EN 60068-2-29 / 16 ms
<b>Vibration resistance</b>	5 g, 10 Hz ... 55 Hz (IEC 68-2-6)
<b>EMC</b>	EN 60947-5-2
<b>Ambient light immunity</b>	Direct: 100,000 lx <sup>1)</sup> Indirect: 150,000 lx
<b>Ambient operating temperature</b>	-25 °C ... +55 °C
<b>Ambient temperature, storage</b>	-25 °C ... +70 °C

<sup>1)</sup> Sunlight.

### Certificates

<b>EU declaration of conformity</b>	✓
<b>UK declaration of conformity</b>	✓
<b>ACMA declaration of conformity</b>	✓
<b>Moroccan declaration of conformity</b>	✓
<b>China RoHS</b>	✓
<b>Information according to Art. 3 of Data Act (Regulation EU 2023/2854)</b>	✓

### Classifications

<b>ECLASS 5.0</b>	27270910
-------------------	----------

<b>ECLASS 5.1.4</b>	27270910
<b>ECLASS 6.0</b>	27270910
<b>ECLASS 6.2</b>	27270910
<b>ECLASS 7.0</b>	27270910
<b>ECLASS 8.0</b>	27270910
<b>ECLASS 8.1</b>	27270910
<b>ECLASS 9.0</b>	27270910
<b>ECLASS 10.0</b>	27270910
<b>ECLASS 11.0</b>	27270910
<b>ECLASS 12.0</b>	27270910
<b>ETIM 5.0</b>	EC002549
<b>ETIM 6.0</b>	EC002549
<b>ETIM 7.0</b>	EC002549
<b>ETIM 8.0</b>	EC002549
<b>UNSPSC 16.0901</b>	39121528

Dimensional drawing Sxx-Fxxxxxx2xxx

Flat, with stabilizer

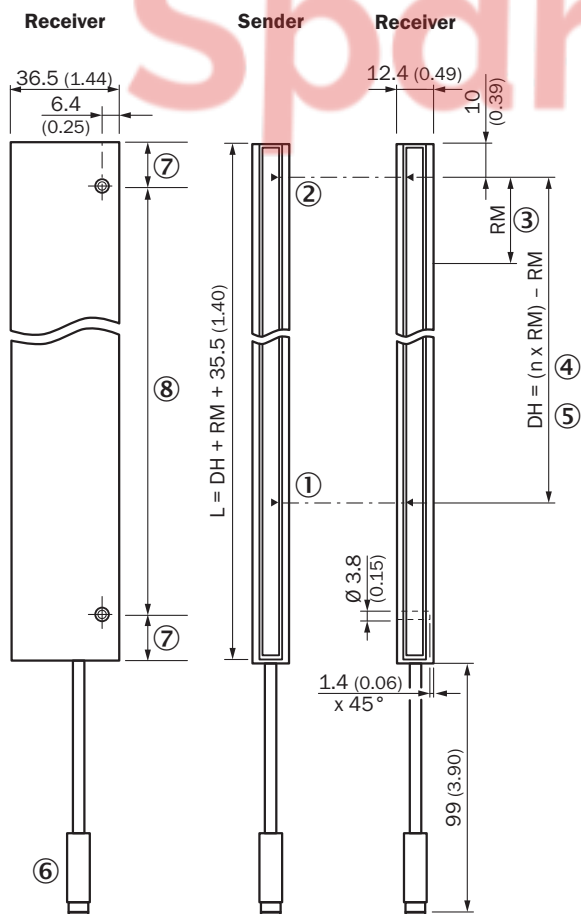

Dimensions in mm (inch)

- ① First beam
- ② last beam
- ③ beam separation (RM)
- ④ number of beams (n)
- ⑤ detection height (DH)
- ⑥ Connection
- ⑦ Same distance
- ⑧ see table (hole spacing stabilizer)

Hole spacing stabilizer			
Monitoring height (MH)	Number of holes	Distance between the holes	Distance first hole to the last hole
0120	2	160	160
0280	2	320	320
0440	2	320	320
0600	3	320	640
0760	3	320	640
0920	4	320	960
1080	4	320	960
1240	5	320	1280
1400	5	320	1280

Connection type and diagram

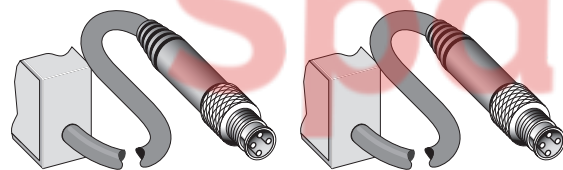

Sender

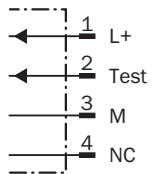

Receiver

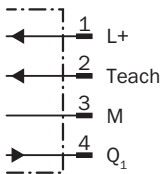

Specific features

Optical synchronization

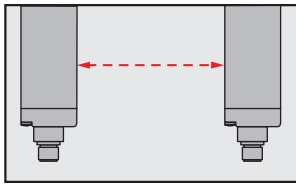

The light grid communicates via the light beams. A cable is not necessary for the optical synchronization.



Slim & Flat



- ① Slim model = light emission on narrow side
- ② Flat model = light emission on broad side

Recommended accessories

Other models and accessories → [www.sick.com/SLG](http://www.sick.com/SLG)

	Brief description	Type	part no.
connectors and cables			
	<ul style="list-style-type: none"> <li>• <b>Connection type head A:</b> Female connector, M8, 4-pin, straight, A-coded</li> <li>• <b>Connection type head B:</b> Flying leads</li> <li>• <b>Signal type:</b> Sensor/actuator cable</li> <li>• <b>Cable:</b> 2 m, 4-wire, PVC</li> <li>• <b>Description:</b> Sensor/actuator cable, unshielded</li> <li>• <b>Application:</b> Zones with chemicals, Untaminated zones</li> </ul>	YF8U14-020VA3XLEAX	2095888
	<ul style="list-style-type: none"> <li>• <b>Connection type head A:</b> Female connector, M8, 4-pin, straight, A-coded</li> <li>• <b>Connection type head B:</b> Flying leads</li> <li>• <b>Signal type:</b> Sensor/actuator cable</li> <li>• <b>Cable:</b> 0.6 m, 4-wire, PVC</li> <li>• <b>Description:</b> Sensor/actuator cable, unshielded</li> <li>• <b>Application:</b> Zones with chemicals, Untaminated zones</li> </ul>	YF8U14-C60VA3XLEAX	2145852
	<ul style="list-style-type: none"> <li>• <b>Connection type head A:</b> Female connector, M8, 4-pin, straight, A-coded</li> <li>• <b>Connection type head B:</b> Flying leads</li> <li>• <b>Signal type:</b> Sensor/actuator cable</li> <li>• <b>Cable:</b> 1 m, 4-wire, PVC</li> <li>• <b>Description:</b> Sensor/actuator cable, unshielded</li> <li>• <b>Application:</b> Zones with chemicals, Untaminated zones</li> </ul>	YF8U14-010VA3XLEAX	2145853

## SICK AT A GLANCE

SICK is one of the leading manufacturers of intelligent sensors and sensor solutions for industrial applications. A unique range of products and services creates the perfect basis for controlling processes securely and efficiently, protecting individuals from accidents and preventing damage to the environment.

We have extensive experience in a wide range of industries and understand their processes and requirements. With intelligent sensors, we can deliver exactly what our customers need. In application centers in Europe, Asia and North America, system solutions are tested and optimized in accordance with customer specifications. All this makes us a reliable supplier and development partner.

Comprehensive services complete our offering: SICK LifeTime Services provide support throughout the machine life cycle and ensure safety and productivity.

For us, that is “Sensor Intelligence.”

### WORLDWIDE PRESENCE:

Contacts and other locations – [www.sick.com](http://www.sick.com)

SpareCruX