



KUP-1010-D

Shaft couplings

SHAFT ADAPTATION

SICK
Sensor Intelligence.



Ordering information

Type	part no.
KUP-1010-D	5326703

Other models and accessories → www.sick.com/Shaft_couplings

Detailed technical data

Features

Product segment	Shaft adaptation
Product	Shaft couplings
Shaft diameter D1	10 mm
Shaft diameter D2	10 mm
Length	35 mm
Maximum speed	3,000 min ⁻¹
Maximum shaft offset - radial	± 2.5 mm
Maximum shaft offset - axial	± 3 mm
Maximum shaft offset - angular	± 10°
Max. torque	150 Ncm
Description	Double loop coupling, shaft diameter 10 mm / 10 mm, Maximum shaft offset: radial +/- 2.5 mm, axial +/- 3 mm, angular +/- 10°; max. speed 3,000 rpm, -30° to +80 °C, max. torque 1.5 Nm; material: polyurethane, galvanized steel flange

Classifications

ECLASS 5.0	23031190
ECLASS 5.1.4	23031190
ECLASS 6.0	23031190
ECLASS 6.2	23031190
ECLASS 7.0	23031190
ECLASS 8.0	23031190
ECLASS 8.1	23031190
ECLASS 9.0	23031190
ECLASS 10.0	23031190
ECLASS 11.0	23031190
ECLASS 12.0	23031190
UNSPSC 16.0901	31163014

Dimensional drawing

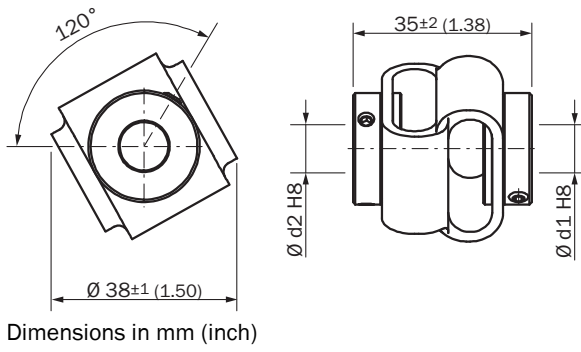

SpareCruX

SICK AT A GLANCE

SICK is one of the leading manufacturers of intelligent sensors and sensor solutions for industrial applications. A unique range of products and services creates the perfect basis for controlling processes securely and efficiently, protecting individuals from accidents and preventing damage to the environment.

We have extensive experience in a wide range of industries and understand their processes and requirements. With intelligent sensors, we can deliver exactly what our customers need. In application centers in Europe, Asia and North America, system solutions are tested and optimized in accordance with customer specifications. All this makes us a reliable supplier and development partner.

Comprehensive services complete our offering: SICK LifeTime Services provide support throughout the machine life cycle and ensure safety and productivity.

For us, that is “Sensor Intelligence.”

WORLDWIDE PRESENCE:

Contacts and other locations – www.sick.com

SpareCruX