



IM18-05B-N-ZW0

IMN

INDUCTIVE PROXIMITY SENSORS

SICK
Sensor Intelligence.



Illustration may differ



Ordering information

Type	part no.
IM18-05B-N-ZW0	6021126

Included in delivery: BEF-MU-M18 (1)

Other models and accessories → www.sick.com/IMN

Detailed technical data

Features

Housing	Metric
Thread size	M18 x 1
Diameter	Ø 18 mm
Sensing range S_n	5 mm
Safe sensing range S_a	4.05 mm
Installation type	Flush
Switching frequency	720 Hz
Connection type	Cable, 2-wire, 2 m
Switching output	NAMUR
Switching output detail	NAMUR
Output function	NC
Enclosure rating	IP67 ¹⁾
Special applications	Explosive areas
Items supplied	Mounting nut, brass, nickel-plated (2x)

¹⁾ According to EN 60529.

Mechanics/electronics

Supply voltage	7.5 V DC ... 25 V DC ¹⁾
Hysteresis	1 % ... 15 %
Temperature drift (of S_n)	± 10 %
EMC	According to EN 60947-5-6

¹⁾ When used outside the hazardous area.

²⁾ For connection to a separately certified intrinsically safe circuit only.

³⁾ 1 kΩ.

Current consumption, sensor is activated	≤ 1 mA
Current consumption, sensor is not activated	≥ 2.2 mA
Cable material	PVC
Conductor size	0.5 mm ²
Cable diameter	Ø 5.4 mm
Cable resistance	50 Ω
Shock and vibration resistance	30 g, 11 ms / 10 ... 55 Hz, 1 mm
Ambient operating temperature	-20 °C ... +70 °C
Housing material	Brass, nickel-plated
Sensing face material	Plastic, PTB
Housing length	33 mm
Thread length	32 mm
Tightening torque, max.	35 Nm
Weight	+ 171 g
Type approval certificate	PTB 03 ATEX 2037
Ex area category	1G, 2G
Input voltage U_i max.	15 V ²⁾
Input power P_i max.	120 mW ²⁾
Input current I_i max.	50 mA ²⁾
Internal capacitance C_i max.	145 nF ²⁾
Internal inductance L_i max.	45 µH ²⁾
Nominal voltage	8.2 V DC ³⁾
Device labeling	II 1G Ex ia IIC T6 Ga Ta -20 °C ... +70 °C, II 2 G Ex ia IIC T6 Gb Ta: -20 °C ... +70 °C

¹⁾ When used outside the hazardous area.

²⁾ For connection to a separately certified intrinsically safe circuit only.

³⁾ 1 kΩ.

Safety-related parameters

MTTF_D	7,515 years
DC_{avg}	0%
T_M (mission time)	20 years

Reduction factors

Note	The values are reference values which may vary
Stainless steel (V2A, 304)	Approx. 0.7
Aluminum (Al)	Approx. 0.4
Copper (Cu)	Approx. 0.3
Brass (Br)	Approx. 0.5

Installation note

Remark	Associated graphic see "Installation"
B	18 mm

C	18 mm
D	15 mm
F	40 mm

Certificates

EU declaration of conformity	✓
UK declaration of conformity	✓
ACMA declaration of conformity	✓
Moroccan declaration of conformity	✓
China RoHS	✓
CCC certificate	✓
ATEX certificate	✓

Classifications

ECLASS 5.0	27270101
ECLASS 5.1.4	27270101
ECLASS 6.0	27270101
ECLASS 6.2	27270101
ECLASS 7.0	27270101
ECLASS 8.0	27270101
ECLASS 8.1	27270101
ECLASS 9.0	27270101
ECLASS 10.0	27270101
ECLASS 11.0	27270101
ECLASS 12.0	27274001
ETIM 5.0	EC002714
ETIM 6.0	EC002714
ETIM 7.0	EC002714
ETIM 8.0	EC002714
UNSPSC 16.0901	39122230

Installation note Flush installation

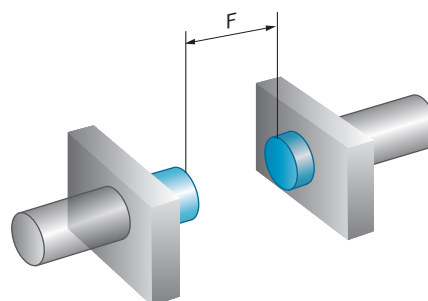
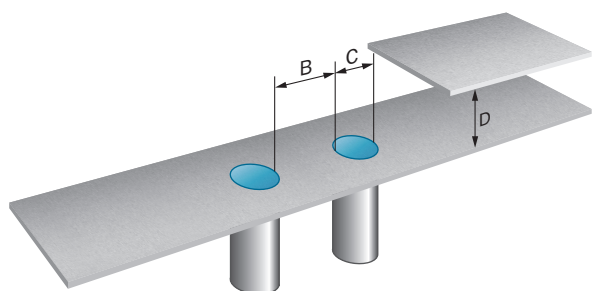

Connection type

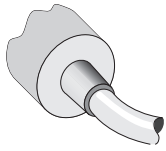

Connection diagram Cd-012

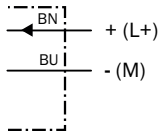

Dimensional drawing IM18 Namur, flush

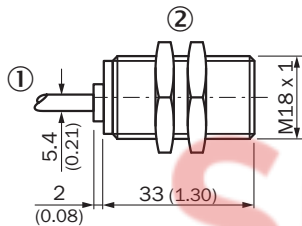

Dimensions in mm (inch)



① Connection

② Fastening nuts (2x); width across 24, metal

Recommended accessories

Other models and accessories → www.sick.com/IMN

	Brief description	Type	part no.
integration modules and adapters			
	<ul style="list-style-type: none"> Description: NAMUR isolating amplifier, Cable fault detection, Switching outputs: 2 NO relay (1 per channel), Supply voltage: 24 V ... 230 V, Voltage type: AC/DC 	EN2-2EX1	6041096

	Brief description	Type	part no.
Mounting systems			
	<ul style="list-style-type: none"> Description: Plate N06 for universal clamp bracket, M18 Material: Steel, zinc diecast Details: Zinc plated steel (sheet), Zinc die cast (clamping bracket) Items supplied: Universal clamp (5322626), mounting hardware Usable for: MH15, MH15V, V180-2, V18V, W15, GR18, V18, V18 Laser, V12-2, SimpleSense, SureSense, M18 round sensors 	BEF-KHS-N06	2051612
	<ul style="list-style-type: none"> Description: Mounting plate for M18 sensors Material: Steel Details: Steel, zinc coated Items supplied: Without mounting hardware Suitable for: GR18, V180-2, V18, W15, Z1, Z2 	BEF-WG-M18	5321870
	<ul style="list-style-type: none"> Description: Mounting bracket for M18 sensors Material: Steel Details: Steel, zinc coated Items supplied: Without mounting hardware Suitable for: GR18, V180-2, V18, W15, Z1, Z2 	BEF-WN-M18	5308446
	<ul style="list-style-type: none"> Description: Mounting bracket for M18 sensors Material: Stainless steel Details: Stainless steel Items supplied: Without mounting hardware 	BEF-WN-M18N	5320947
connectors and cables			
	<ul style="list-style-type: none"> Connection type head A: Male connector, M8, 3-pin, straight, A-coded Description: Unshielded Connection systems: Screw-type terminals Permitted cross-section: 0.14 mm² ... 0.5 mm² 	STE-0803-G	6037322

SparesCruX

SICK AT A GLANCE

SICK is one of the leading manufacturers of intelligent sensors and sensor solutions for industrial applications. A unique range of products and services creates the perfect basis for controlling processes securely and efficiently, protecting individuals from accidents and preventing damage to the environment.

We have extensive experience in a wide range of industries and understand their processes and requirements. With intelligent sensors, we can deliver exactly what our customers need. In application centers in Europe, Asia and North America, system solutions are tested and optimized in accordance with customer specifications. All this makes us a reliable supplier and development partner.

Comprehensive services complete our offering: SICK LifeTime Services provide support throughout the machine life cycle and ensure safety and productivity.

For us, that is “Sensor Intelligence.”

WORLDWIDE PRESENCE:

Contacts and other locations – www.sick.com

SpareCruX