



IM30-15N-N-ZW0

IMN

INDUCTIVE PROXIMITY SENSORS

**SICK**  
Sensor Intelligence.



Illustration may differ



### Ordering information

Type	part no.
IM30-15N-N-ZW0	6021129

**Included in delivery:** BEF-MU-M30 (1)

Other models and accessories → [www.sick.com/IMN](http://www.sick.com/IMN)

### Detailed technical data

#### Features

<b>Housing</b>	Metric
<b>Thread size</b>	M30 x 1.5
<b>Diameter</b>	Ø 30 mm
<b>Sensing range <math>S_n</math></b>	15 mm
<b>Safe sensing range <math>S_a</math></b>	12.15 mm
<b>Installation type</b>	Non-flush
<b>Switching frequency</b>	200 Hz
<b>Connection type</b>	Cable, 2-wire, 2 m
<b>Switching output</b>	NAMUR
<b>Switching output detail</b>	NAMUR
<b>Output function</b>	NC
<b>Enclosure rating</b>	IP67 <sup>1)</sup>
<b>Special applications</b>	Explosive areas
<b>Items supplied</b>	Mounting nut, brass, nickel-plated (2x)

<sup>1)</sup> According to EN 60529.

#### Mechanics/electronics

<b>Supply voltage</b>	7.5 V DC ... 25 V DC <sup>1)</sup>
<b>Hysteresis</b>	1 % ... 15 %
<b>Temperature drift (of <math>S_n</math>)</b>	± 10 %
<b>EMC</b>	According to EN 60947-5-6

<sup>1)</sup> When used outside the hazardous area.

<sup>2)</sup> For connection to a separately certified intrinsically safe circuit only.

<sup>3)</sup> 1 kΩ.

<b>Current consumption, sensor is activated</b>	≤ 1 mA
<b>Current consumption, sensor is not activated</b>	≥ 2.2 mA
<b>Cable material</b>	PVC
<b>Conductor size</b>	0.5 mm <sup>2</sup>
<b>Cable diameter</b>	Ø 5.4 mm
<b>Cable resistance</b>	50 Ω
<b>Shock and vibration resistance</b>	30 g, 11 ms / 10 ... 55 Hz, 1 mm
<b>Ambient operating temperature</b>	-20 °C ... +70 °C
<b>Housing material</b>	Brass, nickel-plated
<b>Sensing face material</b>	Plastic, PTB
<b>Housing length</b>	41 mm
<b>Thread length</b>	25 mm
<b>Tightening torque, max.</b>	≤ 50 Nm
<b>Weight</b>	+ 220 g
<b>Type approval certificate</b>	PTB 03 ATEX 2037
<b>Ex area category</b>	1G, 2G
<b>Input voltage U<sub>i</sub> max.</b>	15 V <sup>2)</sup>
<b>Input power P<sub>i</sub> max.</b>	120 mW <sup>2)</sup>
<b>Input current I<sub>i</sub> max.</b>	50 mA <sup>2)</sup>
<b>Internal capacitance C<sub>i</sub> max.</b>	145 nF <sup>2)</sup>
<b>Internal inductance L<sub>i</sub> max.</b>	110 μH <sup>2)</sup>
<b>Nominal voltage</b>	8.2 V DC <sup>3)</sup>
<b>Device labeling</b>	II 1G Ex ia IIC T6 Ga Ta -20 °C ... +70 °C, II 2 G Ex ia IIC T6 Gb Ta: -20 °C ... +70 °C

<sup>1)</sup> When used outside the hazardous area.

<sup>2)</sup> For connection to a separately certified intrinsically safe circuit only.

<sup>3)</sup> 1 kΩ.

### Safety-related parameters

<b>MTTF<sub>D</sub></b>	7,515 years
<b>DC<sub>avg</sub></b>	0%
<b>T<sub>M</sub> (mission time)</b>	20 years

### Reduction factors

<b>Note</b>	The values are reference values which may vary
<b>Stainless steel (V2A, 304)</b>	Approx. 0.7
<b>Aluminum (Al)</b>	Approx. 0.4
<b>Copper (Cu)</b>	Approx. 0.3
<b>Brass (Br)</b>	Approx. 0.5

### Installation note

<b>Remark</b>	Associated graphic see "Installation"
<b>A</b>	30 mm

<b>B</b>	60 mm
<b>C</b>	30 mm
<b>D</b>	45 mm
<b>E</b>	30 mm
<b>F</b>	120 mm

Certificates

<b>EU declaration of conformity</b>	✓
<b>UK declaration of conformity</b>	✓
<b>ACMA declaration of conformity</b>	✓
<b>Moroccan declaration of conformity</b>	✓
<b>China RoHS</b>	✓
<b>CCC certificate</b>	✓
<b>ATEX certificate</b>	✓

Classifications

<b>ECLASS 5.0</b>	27270101
<b>ECLASS 5.1.4</b>	27270101
<b>ECLASS 6.0</b>	27270101
<b>ECLASS 6.2</b>	27270101
<b>ECLASS 7.0</b>	27270101
<b>ECLASS 8.0</b>	27270101
<b>ECLASS 8.1</b>	27270101
<b>ECLASS 9.0</b>	27270101
<b>ECLASS 10.0</b>	27270101
<b>ECLASS 11.0</b>	27270101
<b>ECLASS 12.0</b>	27274001
<b>ETIM 5.0</b>	EC002714
<b>ETIM 6.0</b>	EC002714
<b>ETIM 7.0</b>	EC002714
<b>ETIM 8.0</b>	EC002714
<b>UNSPSC 16.0901</b>	39122230

Installation note Non-flush installation



Connection type

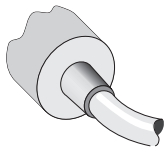

Connection diagram Cd-012

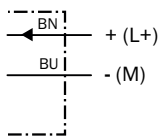

SpareCruX

Dimensional drawing IM30 Namur, non flush

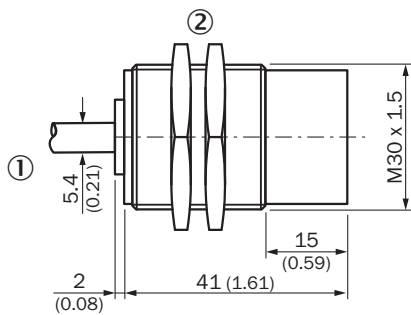





Dimensions in mm (inch)

① Connection

② Fastening nuts (2x); width across 36, metal

Recommended accessories

Other models and accessories → [www.sick.com/IMN](http://www.sick.com/IMN)

	Brief description	Type	part no.
integration modules and adapters			
	<ul style="list-style-type: none"> <li><b>Description:</b> NAMUR isolating amplifier, Cable fault detection, Switching outputs: 2 NO relay (1 per channel), Supply voltage: 24 V ... 230 V, Voltage type: AC/DC</li> </ul>	EN2-2EX1	6041096
Mounting systems			
	<ul style="list-style-type: none"> <li><b>Description:</b> Mounting plate for M30 sensors</li> <li><b>Material:</b> Steel</li> <li><b>Details:</b> Steel, zinc coated</li> <li><b>Items supplied:</b> Without mounting hardware</li> </ul>	BEF-WG-M30	5321871
	<ul style="list-style-type: none"> <li><b>Description:</b> Mounting bracket for M30 sensors</li> <li><b>Material:</b> Steel</li> <li><b>Details:</b> Steel, zinc coated</li> <li><b>Items supplied:</b> Without mounting hardware</li> </ul>	BEF-WN-M30	5308445
connectors and cables			
	<ul style="list-style-type: none"> <li><b>Connection type head A:</b> Male connector, M8, 3-pin, straight, A-coded</li> <li><b>Description:</b> Unshielded</li> <li><b>Connection systems:</b> Screw-type terminals</li> <li><b>Permitted cross-section:</b> 0.14 mm<sup>2</sup> ... 0.5 mm<sup>2</sup></li> </ul>	STE-0803-G	6037322

## SICK AT A GLANCE

SICK is one of the leading manufacturers of intelligent sensors and sensor solutions for industrial applications. A unique range of products and services creates the perfect basis for controlling processes securely and efficiently, protecting individuals from accidents and preventing damage to the environment.

We have extensive experience in a wide range of industries and understand their processes and requirements. With intelligent sensors, we can deliver exactly what our customers need. In application centers in Europe, Asia and North America, system solutions are tested and optimized in accordance with customer specifications. All this makes us a reliable supplier and development partner.

Comprehensive services complete our offering: SICK LifeTime Services provide support throughout the machine life cycle and ensure safety and productivity.

For us, that is “Sensor Intelligence.”

### WORLDWIDE PRESENCE:

Contacts and other locations – [www.sick.com](http://www.sick.com)

SpareCruX