



Spare part

VL18-4P2240V

V18

PHOTOELECTRIC SENSORS

**SICK**  
Sensor Intelligence.



Illustration may differ



## Ordering information

Type	part no.
VL18-4P2240V	6035497

Other models and accessories → [www.sick.com/V18](http://www.sick.com/V18)

## Detailed technical data

### Features

<b>Functional principle</b>	Photoelectric retro-reflective sensor
<b>Functional principle detail</b>	With minimum distance to reflector (dual lens system)
<b>Dimensions (W x H x D)</b>	18 mm x 18 mm x 83 mm
<b>Housing design (light emission)</b>	Cylindrical
<b>Housing length</b>	83 mm
<b>Thread diameter (housing)</b>	M18 x 1
<b>Optical axis</b>	Axial
<b>Sensing range max.</b>	0.035 m ... 4.5 m <sup>1)</sup>
<b>Sensing range</b>	0.035 m ... 4 m <sup>1)</sup>
<b>Focus</b>	3°
<b>Type of light</b>	Visible red light
<b>Light source</b>	LED <sup>2)</sup>
<b>Light spot size (distance)</b>	Ø 60 mm (1 m)
<b>Angle of dispersion</b>	3°
<b>Wave length</b>	660 nm
<b>Adjustment</b>	Single teach-in button (Sensing range) Manual, via Touch-Teach-in
<b>Special feature</b>	Detecting transparent objects
<b>Special applications</b>	Hygienic and washdown zones, Detecting transparent objects

<sup>1)</sup> Reflector PL80A.

<sup>2)</sup> Average service life: 100,000 h at T<sub>J</sub> = +25 °C.

## Mechanics/electronics

<b>Supply voltage <math>U_B</math></b>	10 V DC ... 30 V DC <sup>1)</sup>
<b>Ripple</b>	$\pm 10\%$ <sup>2)</sup>
<b>Current consumption</b>	35 mA <sup>3)</sup>
<b>Switching output</b>	PNP <sup>4)</sup>
<b>Switching mode</b>	Light/dark switching <sup>4)</sup>
<b>Switching mode selector</b>	Selectable via L/D control cable
<b>Signal voltage PNP HIGH/LOW</b>	Approx. $V_S - 2.0\text{ V} / 0\text{ V}$
<b>Output current <math>I_{\max}</math></b>	$\leq 100\text{ mA}$
<b>Response time</b>	$\leq 1\text{ ms}$ <sup>5)</sup>
<b>Switching frequency</b>	500 Hz <sup>6)</sup>
<b>Attenuation along light beam</b>	$\geq 20\%$
<b>Connection type</b>	Male connector M12, 4-pin <sup>7)</sup>
<b>Circuit protection</b>	A <sup>8)</sup> B <sup>9)</sup> C <sup>10)</sup> D <sup>11)</sup>
<b>Protection class</b>	III
<b>Weight</b>	120 g
<b>Housing material</b>	Metal, Stainless steel V4A (1.4404, 316L)
<b>Optics material</b>	Plastic, Plan, PPS (Grilamid)
<b>Enclosure rating</b>	IP67 IP68 IP69K <sup>12)</sup>
<b>Special feature</b>	Detecting transparent objects
<b>Ambient operating temperature</b>	$-25\text{ °C} \dots +80\text{ °C}$ <sup>13)</sup>
<b>Ambient temperature, storage</b>	$-40\text{ °C} \dots +80\text{ °C}$
<b>UL File No.</b>	FDA, UL No. NRKH.E181493 & cUL No. NRKH7.E181493

<sup>1)</sup> Limit values.

<sup>2)</sup> May not fall below or exceed  $U_y$  tolerances.

<sup>3)</sup> Without load, at  $V_S 30\text{ V DC}$ .

<sup>4)</sup> Control wire open: dark switching D.ON.

<sup>5)</sup> Signal transit time with resistive load.

<sup>6)</sup> With light/dark ratio 1:1.

<sup>7)</sup> With gold plated contact pins, PPS with FDA certificate.

<sup>8)</sup> A =  $V_S$  connections reverse-polarity protected.

<sup>9)</sup> B = interference suppression.

<sup>10)</sup> D = outputs overcurrent and short-circuit protected.

<sup>11)</sup> D = inputs and output reverse-polarity protected.

<sup>12)</sup> With correct mounted IP69K connector.

<sup>13)</sup>  $+100\text{ °C}$  at max 15 minutes.

## Certificates

<b>EU declaration of conformity</b>	✓
<b>UK declaration of conformity</b>	✓
<b>Moroccan declaration of conformity</b>	✓

<b>China RoHS</b>	✓
<b>cULus certificate</b>	✓

Classifications

<b>ECLASS 5.0</b>	27270902
<b>ECLASS 5.1.4</b>	27270902
<b>ECLASS 6.0</b>	27270902
<b>ECLASS 6.2</b>	27270902
<b>ECLASS 7.0</b>	27270902
<b>ECLASS 8.0</b>	27270902
<b>ECLASS 8.1</b>	27270902
<b>ECLASS 9.0</b>	27270902
<b>ECLASS 10.0</b>	27270902
<b>ECLASS 11.0</b>	27270902
<b>ECLASS 12.0</b>	27270902
<b>ETIM 5.0</b>	EC002717
<b>ETIM 6.0</b>	EC002717
<b>ETIM 7.0</b>	EC002717
<b>ETIM 8.0</b>	EC002717
<b>UNSPSC 16.0901</b>	39121528



Adjustments

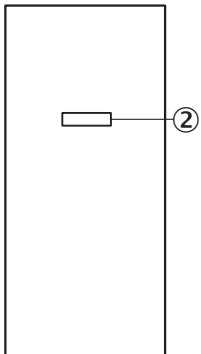

② Sensing range adjustment: Touch-Teach-In

Connection type

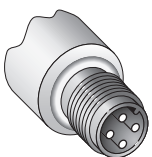

Connection diagram Cd-087

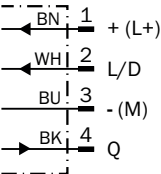

Characteristic curve VL18V, clear material detection

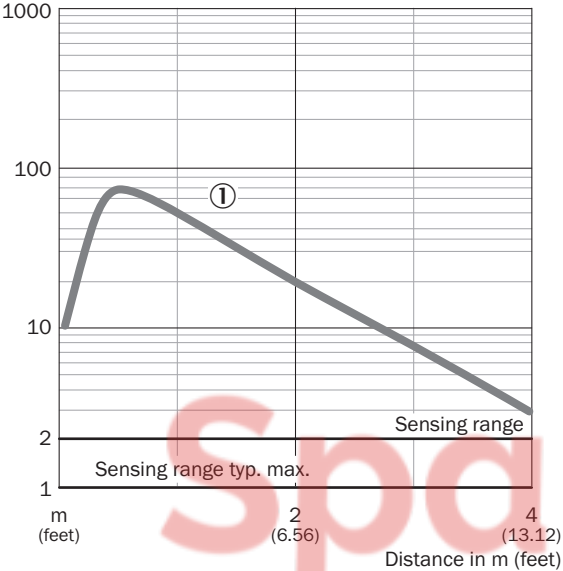

① Reflector PL80A

Sensing range diagram

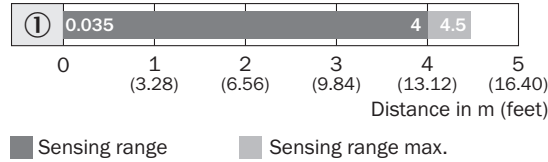

| 1 | PL80A

Dimensional drawing VTF18V, VTE18V

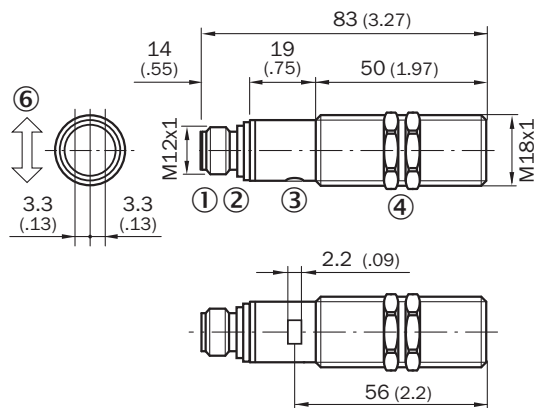



Dimensions in mm (inch)





- ① M12 male device connector, 4-pin
- ② Sensing range adjustment: Touch-Teach-In
- ③ Status indicator LED, green: signaling Touch-Teach-in
- ④ Yellow LED indicator:
- ④ - lights continuously:
- ④ reception signal > reserve factor 2
- ④ - blinks: Reception signal < reserve factor 2 but > switching threshold 1
- ⑤ fastening nuts (2 x); width across 24, stainless steel



Recommended accessories

Other models and accessories → [www.sick.com/V18](http://www.sick.com/V18)

	Brief description	Type	part no.
connectors and cables			
	<ul style="list-style-type: none"> <li>• <b>Connection type head A:</b> Female connector, M12, 4-pin, straight</li> <li>• <b>Connection type head B:</b> Flying leads</li> <li>• <b>Signal type:</b> Sensor/actuator cable</li> <li>• <b>Cable:</b> 5 m, 4-wire, PVC</li> <li>• <b>Description:</b> Sensor/actuator cable, unshielded</li> <li>• <b>Connection systems:</b> Flying leads</li> <li>• <b>Note:</b> This product is generally resistant to chemical cleaning agents (see ECOLAB). Please do not use cleaning agents of any other Kind., Not resistant against lactic acid &amp; hydrogen peroxide (H2O2)</li> <li>• <b>Application:</b> Hygienic and washdown zones</li> </ul>	DOL-1204-G05MNI	6052615
	<ul style="list-style-type: none"> <li>• <b>Connection type head A:</b> Female connector, M12, 4-pin, straight</li> <li>• <b>Connection type head B:</b> Flying leads</li> <li>• <b>Signal type:</b> Sensor/actuator cable</li> <li>• <b>Cable:</b> 5 m, 4-wire, PP</li> <li>• <b>Description:</b> Sensor/actuator cable, unshielded</li> <li>• <b>Connection systems:</b> Flying leads</li> <li>• <b>Note:</b> This product is generally resistant to chemical cleaning agents (see ECOLAB) and other chemical compounds such as H2O2 and CH2O2. Before permanent installation is carried out, the material's resistance to the cleaning agent being used must be checked., Resistant against lactic acid &amp; hydrogen peroxide (H2O2)</li> <li>• <b>Application:</b> Hygienic and washdown zones, Drag chain operation</li> </ul>	DOL-1204-G05MRN	6058476

	Brief description	Type	part no.
Mounting systems			
	<ul style="list-style-type: none"> <li><b>Description:</b> Mounting bracket for M18 sensors</li> <li><b>Material:</b> Stainless steel</li> <li><b>Details:</b> Stainless steel</li> <li><b>Items supplied:</b> Without mounting hardware</li> </ul>	BEF-WN-M18N	5320947
	<ul style="list-style-type: none"> <li><b>Description:</b> Plate N11N for universal clamp bracket</li> <li><b>Material:</b> Stainless steel</li> <li><b>Details:</b> Stainless steel 1.4571 (sheet), Stainless steel 1.4408 (clamp)</li> <li><b>Items supplied:</b> Universal clamp (5322627), mounting hardware</li> <li><b>Usable for:</b> DeltaPac, Glare, WTD20E</li> </ul>	BEF-KHS-N11N	2071081
	<ul style="list-style-type: none"> <li><b>Description:</b> Universal mounting bracket for reflectors</li> <li><b>Dimensions (W x H x L):</b> 85 mm x 90 mm x 35 mm</li> <li><b>Material:</b> Steel</li> <li><b>Details:</b> Steel, zinc coated</li> <li><b>Suitable for:</b> C110A, P250, PL20, PL30A, PL40A, PL80A</li> </ul>	BEF-WN-REFX	2064574
reflectors and optics			
	<ul style="list-style-type: none"> <li><b>Description:</b> Chemically resistant, screw connection</li> <li><b>Dimensions:</b> 52 mm 61 mm</li> <li><b>Ambient operating temperature:</b> -20 °C ... +140 °C</li> </ul>	P250 CHEM	5321097

SpareCruX

## SICK AT A GLANCE

SICK is one of the leading manufacturers of intelligent sensors and sensor solutions for industrial applications. A unique range of products and services creates the perfect basis for controlling processes securely and efficiently, protecting individuals from accidents and preventing damage to the environment.

We have extensive experience in a wide range of industries and understand their processes and requirements. With intelligent sensors, we can deliver exactly what our customers need. In application centers in Europe, Asia and North America, system solutions are tested and optimized in accordance with customer specifications. All this makes us a reliable supplier and development partner.

Comprehensive services complete our offering: SICK LifeTime Services provide support throughout the machine life cycle and ensure safety and productivity.

For us, that is “Sensor Intelligence.”

### WORLDWIDE PRESENCE:

Contacts and other locations – [www.sick.com](http://www.sick.com)

SpareCruX