



UM30-214113

UM30

ULTRASONIC DISTANCE SENSORS

SICK
Sensor Intelligence.



Ordering information

Type	part no.
UM30-214113	6036919

Other models and accessories → www.sick.com/UM30



Detailed technical data

Features

Operating range, limiting range	350 mm ... 3,400 mm, 5,000 mm
Target	Natural objects
Resolution	≥ 0.18 mm
Repeatability	± 0.15 % ¹⁾
Measurement accuracy	± 1 % ^{2) 3)}
Temperature compensation	✓
Response time	180 ms ⁴⁾
Output time	43 ms
Ultrasonic frequency (typical)	120 kHz
Detection area (typical)	See diagrams
Additional function	Teach-in of analog output, scaling of analog outputs, Invertable analog output, automatic selection of analog current or voltage output, synchronization of up to 50 sensors, multiplexing: no cross talk of up to 50 sensors, adjustable measurement filters: Measured value filters/Filter strength/Foreground suppression/Detection area/Sensitivity and sound beam, Display (can be deactivated), reset to factory default
Safety-related parameters	
	MTTF _D 101 years
	DC _{avg} 0%

¹⁾ In relation to the current measured value, minimum value ≥ resolution.

²⁾ Referring to current measurement value.

³⁾ Temperature compensation can be switched off, without temperature compensation: 0.17 % / K.

⁴⁾ Subsequent smoothing of the analog output, depending on the application, may increase the response time by up to 200 %.

Interfaces

Analog output

¹⁾ For 4 mA ... 20 mA and V_s ≤ 20 V max. load ≤ 100 Ω.

Number	1
Type	Current output / voltage output
Function	Automatic selection of analog current or voltage output dependent on load
Current	4 mA ... 20 mA, $\leq 500 \Omega$ ¹⁾
Voltage	0 V ... 10 V, $\geq 100,000 \Omega$
Resolution	12 bit
Multifunctional input (MF)	1 x MF

¹⁾ For 4 mA ... 20 mA and $V_s \leq 20$ V max. load $\leq 100 \Omega$.

Electronics

Supply voltage U_B	DC 9 V ... 30 V ^{1) 2)}
Power consumption	≤ 2.4 W ³⁾
Initialization time	< 300 ms
Indication	LED display, 2 x LED
Enclosure rating	IP65 / IP67
Protection class	III

¹⁾ Limit values, reverse-polarity protected Operation in short-circuit protected network: max. 8 A, class 2.

²⁾ 15 V ... 30 V when using the analog voltage output.

³⁾ Without load.

Mechanics

Dimensions (W x H x D)	47.5 mm x 47.5 mm x 102 mm
Design	Cylindrical
Sending axis	Straight
Housing material	Metal (nickel-plated brass, PBT, ultrasonic transducer: polyurethane foam, glass epoxy resin)
Weight	210 g
Thread size	M30 x 1.5
Connection type	Male connector, M12, 5-pin

Ambient data

Ambient temperature, operation	-25 °C ... +70 °C
Ambient temperature, storage	-40 °C ... +85 °C

Certificates

EU declaration of conformity	✓
UK declaration of conformity	✓
ACMA declaration of conformity	✓
Moroccan declaration of conformity	✓
China RoHS	✓
cULus certificate	✓

Classifications

ECLASS 5.0	27270804
ECLASS 5.1.4	27270804

ECLASS 6.0	27270804
ECLASS 6.2	27270804
ECLASS 7.0	27270804
ECLASS 8.0	27270804
ECLASS 8.1	27270804
ECLASS 9.0	27270804
ECLASS 10.0	27270804
ECLASS 11.0	27270804
ECLASS 12.0	27272806
ETIM 5.0	EC001846
ETIM 6.0	EC001846
ETIM 7.0	EC001846
ETIM 8.0	EC001846
UNSPSC 16.0901	41111960

Dimensional drawing UM30-214

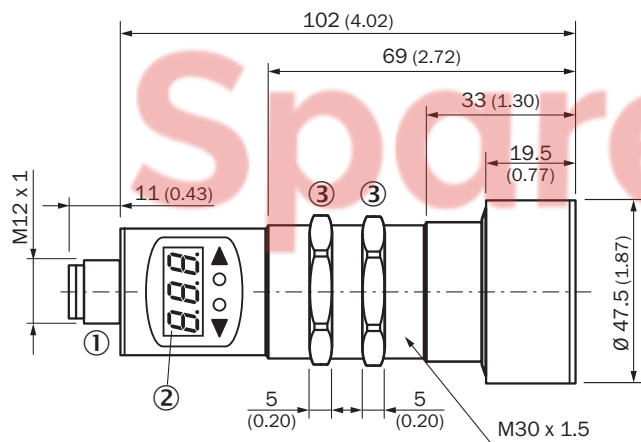

Dimensions in mm (inch)

- ① Connection
- ② Display
- ③ Mounting nuts, SW 36 mm

Connection type

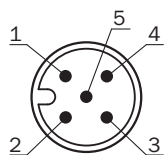

Connection diagram UM30-21x113 Connector M12, 5-pin

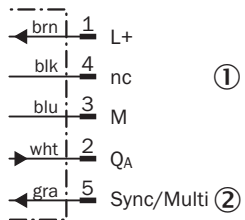

- ① Not assigned
- ② Synchronization and multiplex mode, Connect+ communication

Adjustment possible

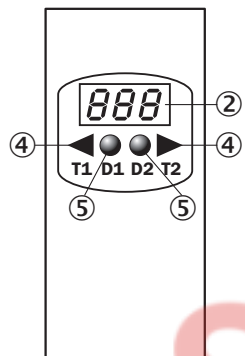

- ② Display
- ④ Control elements
- ⑤ Status indicators



Detection area

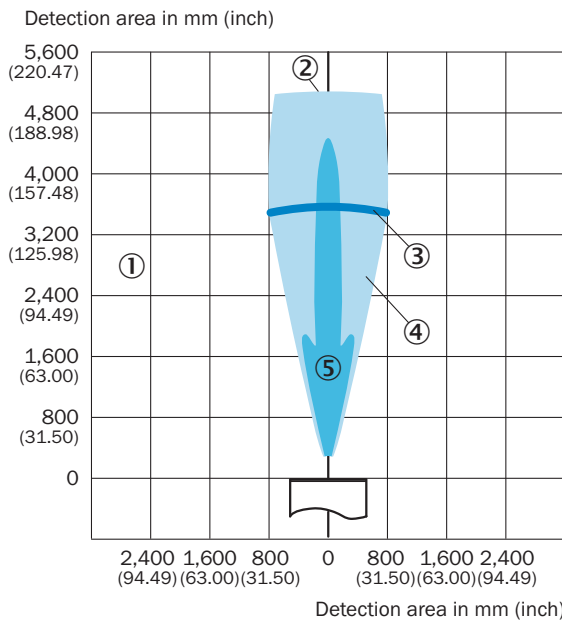





- ① Detection range dependent on reflection properties, size, and alignment of the object

- ② Limiting range
- ③ operating range
- ④ example object: aligned plate 500 mm x 500 mm
- ⑤ example object: pipe with 27 mm diameter

Recommended accessories

Other models and accessories → www.sick.com/UM30

	Brief description	Type	part no.
programming devices			
	<ul style="list-style-type: none"> Product segment: Integration modules and adapters Product family: Cloning modules Description: Tool for visualization, configuration and cloning, 3-digit LED display, supply voltage: DV 9 V ... 30 V 	Connect+ adapter (CPA)	6037782
Mounting systems			
	<ul style="list-style-type: none"> Description: Mounting bracket for M30 sensors Material: Steel Details: Steel, zinc coated Items supplied: Without mounting hardware 	BEF-WN-M30	5308445
connectors and cables			
	<ul style="list-style-type: none"> Connection type head A: Female connector, M12, 5-pin, straight, A-coded Connection type head B: Flying leads Signal type: Sensor/actuator cable Cable: 2 m, 5-wire, PVC Description: Sensor/actuator cable, unshielded Application: Zones with chemicals, Untaminated zones 	YF2A15-020VB5XLEAX	2096239
	<ul style="list-style-type: none"> Connection type head A: Female connector, M12, 5-pin, straight, A-coded Connection type head B: Flying leads Signal type: Sensor/actuator cable Cable: 0.6 m, 5-wire, PVC Description: Sensor/actuator cable, unshielded Application: Zones with chemicals, Untaminated zones 	YF2A15-C60VB5XLEAX	2145570
	<ul style="list-style-type: none"> Connection type head A: Female connector, M12, 5-pin, straight, A-coded Connection type head B: Flying leads Signal type: Sensor/actuator cable Cable: 3 m, 5-wire, PVC Description: Sensor/actuator cable, unshielded Application: Zones with chemicals, Untaminated zones 	YF2A15-030VB5XLEAX	2145572

SICK AT A GLANCE

SICK is one of the leading manufacturers of intelligent sensors and sensor solutions for industrial applications. A unique range of products and services creates the perfect basis for controlling processes securely and efficiently, protecting individuals from accidents and preventing damage to the environment.

We have extensive experience in a wide range of industries and understand their processes and requirements. With intelligent sensors, we can deliver exactly what our customers need. In application centers in Europe, Asia and North America, system solutions are tested and optimized in accordance with customer specifications. All this makes us a reliable supplier and development partner.

Comprehensive services complete our offering: SICK LifeTime Services provide support throughout the machine life cycle and ensure safety and productivity.

For us, that is “Sensor Intelligence.”

WORLDWIDE PRESENCE:

Contacts and other locations – www.sick.com

SpareCruX