



VL180-2F32331

V180

PHOTOELECTRIC SENSORS

SICK
Sensor Intelligence.



Ordering information

Type	part no.
VL180-2F32331	6043458

Included in delivery: P250 (1)

Other models and accessories → www.sick.com/V180

Illustration may differ

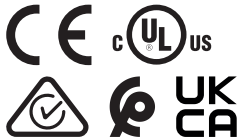

Detailed technical data

Features

Functional principle	Photoelectric retro-reflective sensor
Functional principle detail	With minimum distance to reflector (dual lens system)
Dimensions (W x H x D)	18 mm x 18 mm x 70.2 mm
Housing design (light emission)	Cylindrical
Housing length	70.2 mm
Thread diameter (housing)	M18 x 1
Optical axis	Axial
Sensing range max.	0.05 m ... 7 m ¹⁾
Sensing range	0.05 m ... 6 m ¹⁾
Focus	Approx. 4.5°
Type of light	Visible red light
Light source	LED ²⁾
Light spot size (distance)	Ø 400 mm (6 m)
Angle of dispersion	Approx. 4.5°
Wave length	645 nm
Adjustment	Potentiometer, 270° (Sensitivity)

¹⁾ Reflector PL80A.

²⁾ Average service life: 100,000 h at T_U = +25 °C.

Mechanics/electronics

Supply voltage U_B	10 V DC ... 30 V DC ¹⁾
Ripple	$\pm 10\%$ ²⁾
Current consumption	30 mA ³⁾
Switching output	PNP
Switching mode	Light switching
Signal voltage PNP HIGH/LOW	Approx. $V_S - 1.8\text{ V} / 0\text{ V}$
Output current I_{\max}	$\leq 100\text{ mA}$
Response time	$\leq 0.5\text{ ms}$ ⁴⁾
Switching frequency	1,000 Hz ⁵⁾
Connection type	Male connector M12, 4-pin
Circuit protection	A ⁶⁾ B ⁷⁾ D ⁸⁾
Protection class	III
Weight	47 g
Polarisation filter	✓
Housing material	Metal, Nickel-plated brass and PC
Optics material	Plastic, PMMA
Enclosure rating	IP67
Items supplied	Reflector P250, fastening nuts (2 x)
Ambient operating temperature	$-25\text{ °C} \dots +55\text{ °C}$
Ambient temperature, storage	$-40\text{ °C} \dots +70\text{ °C}$
UL File No.	NRKH2.E300503 & NRKH8.E300503

¹⁾ Limit values when operated in short-circuit protected network: max. 8 A.

²⁾ May not fall below or exceed U_V tolerances.

³⁾ Without load.

⁴⁾ Signal transit time with resistive load.

⁵⁾ With light/dark ratio 1:1.

⁶⁾ A = V_S connections reverse-polarity protected.

⁷⁾ B = inputs and output reverse-polarity protected.

⁸⁾ D = outputs overcurrent and short-circuit protected.

Safety-related parameters

MTTF_D	1,883.8 years
DC_{avg}	0 %

Certificates

EU declaration of conformity	✓
UK declaration of conformity	✓
ACMA declaration of conformity	✓
Moroccan declaration of conformity	✓
China RoHS	✓
cULus certificate	✓

Photobiological safety (DIN EN 62471) certificate	✓
--	---

Classifications

ECLASS 5.0	27270902
ECLASS 5.1.4	27270902
ECLASS 6.0	27270902
ECLASS 6.2	27270902
ECLASS 7.0	27270902
ECLASS 8.0	27270902
ECLASS 8.1	27270902
ECLASS 9.0	27270902
ECLASS 10.0	27270902
ECLASS 11.0	27270902
ECLASS 12.0	27270902
ETIM 5.0	EC002717
ETIM 6.0	EC002717
ETIM 7.0	EC002717
ETIM 8.0	EC002717
UNSPSC 16.0901	39121528



Adjustments

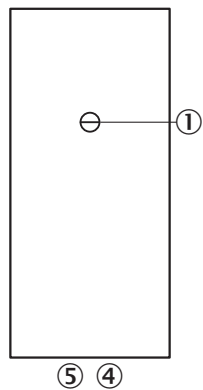

- ① sensitivity control 270°
- ④ LED indicator orange: switching output active
- ⑤ LED indicator green

Connection type

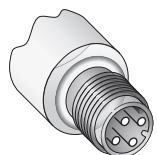

Connection diagram Cd-066



Characteristic curve VL180-2, 7 m, axial

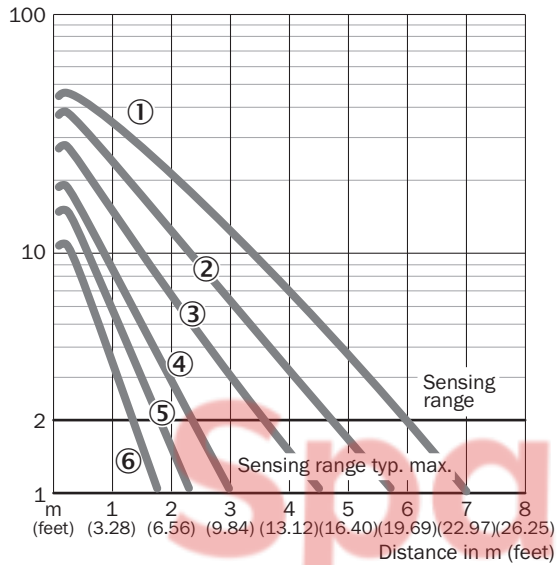

- ① Reflector PL80A
- ② Reflector P250, PL40A, PL50A, C110A
- ③ Reflector PL30A, PL31A
- ④ Reflector PL20A
- ⑤ P45
- ⑥ Reflective tape Diamond Grade

Light spot size VL180-2

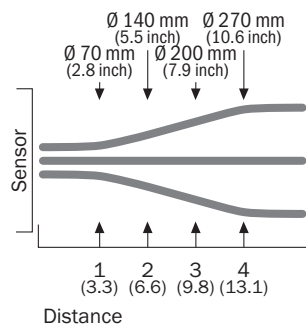

Sensing range diagram VL180-2, 7 m, axial

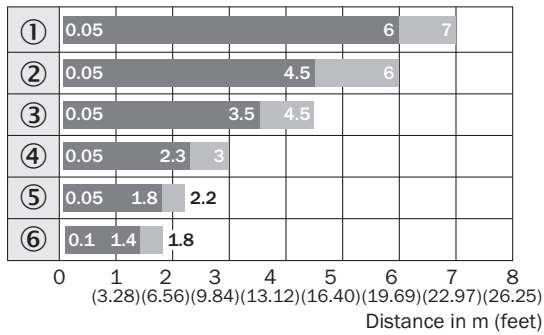

■ Sensing range ■ Sensing range max.

- ① Reflector PL80A
- ② Reflector P250, PL40A, PL50A, C110A
- ③ Reflector PL30A, PL31A
- ④ Reflector PL20A
- ⑤ P45
- ⑥ Reflective tape Diamond Grade

Dimensional drawing VL180-2, metal, axial

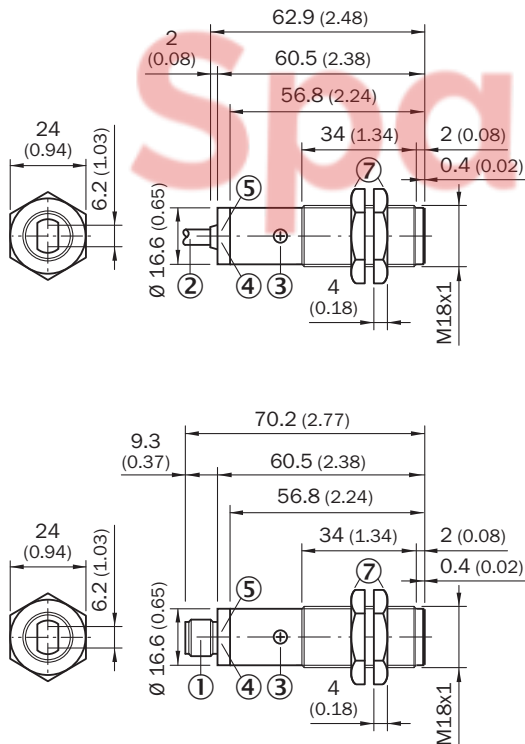







Dimensions in mm (inch)

- ① M12 male device connector, 4-pin
- ② Connection cable 2 m
- ③ sensitivity control 270°
- ④ LED indicator orange: switching output active
- ⑤ LED indicator green: strength indicator
- ⑦ Fastening nuts (2x); width across 24, metal

Recommended accessories

Other models and accessories → www.sick.com/V180

	Brief description	Type	part no.
Mounting systems			
	<ul style="list-style-type: none"> Description: Mounting bracket for M18 sensors Material: Steel Details: Steel, zinc coated Items supplied: Without mounting hardware Suitable for: GR18, V180-2, V18, W15, Z1, Z2 	BEF-WN-M18	5308446
	<ul style="list-style-type: none"> Description: Plate N11N for universal clamp bracket Material: Stainless steel Details: Stainless steel 1.4571 (sheet), Stainless steel 1.4408 (clamp) Items supplied: Universal clamp (5322627), mounting hardware Usable for: DeltaPac, Glare, WTD20E 	BEF-KHS-N11N	2071081
reflectors and optics			
	<ul style="list-style-type: none"> Description: Rectangular, screw connection Dimensions: 51 mm 61 mm Ambient operating temperature: -30 °C ... +65 °C 	P250	5304812
connectors and cables			
	<ul style="list-style-type: none"> Connection type head A: Female connector, M12, 4-pin, straight, A-coded Connection type head B: Flying leads Signal type: Sensor/actuator cable Cable: 5 m, 4-wire, PVC Description: Sensor/actuator cable, unshielded Application: Zones with chemicals, Uncontaminated zones 	YF2A14-050VB3XLEAX	2096235
	<ul style="list-style-type: none"> Connection type head A: Male connector, M12, 4-pin, straight, A-coded Description: Unshielded Connection systems: Screw-type terminals Permitted cross-section: ≤ 0.75 mm² 	STE-1204-G	6009932
	<ul style="list-style-type: none"> Connection type head A: Female connector, M12, 4-pin, straight, A-coded Connection type head B: Flying leads Signal type: Sensor/actuator cable Cable: 5 m, 4-wire, PUR, halogen-free Description: Sensor/actuator cable, unshielded Application: Uncontaminated zones, Zones with oils and lubricants, Robot, Drag chain operation 	YF2A14-050UB3XLEAX	2095608

SICK AT A GLANCE

SICK is one of the leading manufacturers of intelligent sensors and sensor solutions for industrial applications. A unique range of products and services creates the perfect basis for controlling processes securely and efficiently, protecting individuals from accidents and preventing damage to the environment.

We have extensive experience in a wide range of industries and understand their processes and requirements. With intelligent sensors, we can deliver exactly what our customers need. In application centers in Europe, Asia and North America, system solutions are tested and optimized in accordance with customer specifications. All this makes us a reliable supplier and development partner.

Comprehensive services complete our offering: SICK LifeTime Services provide support throughout the machine life cycle and ensure safety and productivity.

For us, that is “Sensor Intelligence.”

WORLDWIDE PRESENCE:

Contacts and other locations – www.sick.com

SpareCruX