



UM18-217127112

UM18

ULTRASONIC DISTANCE SENSORS

SICK
Sensor Intelligence.



Ordering information

Type	part no.
UM18-217127112	6048389

Other models and accessories → www.sick.com/UM18



Detailed technical data

Features

Operating range, limiting range	20 mm ... 150 mm, 250 mm
Target	Natural objects
Resolution	≥ 0.069 mm
Repeatability	± 0.15 % ¹⁾
Measurement accuracy	± 1 % ^{2) 3)}
Temperature compensation	✓
Response time	32 ms ⁴⁾
Output time	8 ms
Ultrasonic frequency (typical)	380 kHz
Additional function	Teach-in of analog output, Invertable analog output, multifunctional input: external teach / synchronization / multiplexing, synchronization of up to 20 sensors, multiplexing: no cross talk of up to 20 sensors, reset to factory default
Safety-related parameters	
	MTTF _D 101 years
	DC _{avg} 0%

¹⁾ In relation to the current measured value, minimum value ≥ resolution.

²⁾ Referring to current measurement value.

³⁾ Temperature compensation can be switched off, without temperature compensation: 0.17 % / K.

⁴⁾ Subsequent smoothing of the analog output, depending on the application, may increase the response time by up to 200 %.

Interfaces

Analog output		
	Number	1
	Type	Voltage output
	Voltage	0 V ... 10 V, ≥ 100,000 Ω
	Resolution	12 bit
Multifunctional input (MF)		1 x MF

Electronics

Supply voltage U_B	DC 10 V ... 30 V ¹⁾
Power consumption	≤ 1.2 W ²⁾
Initialization time	< 300 ms
Display	2 x LED
Enclosure rating	IP65 / IP67
Protection class	III

¹⁾ Limit values, reverse-polarity protected Operation in short-circuit protected network: max. 8 A, class 2.

²⁾ Without load.

Mechanics

Dimensions (W x H x D)	18 mm x 18 mm x 68.7 mm
Design	Cylindrical
Sending axis	Angled
Housing material	Metal (nickel-plated brass, ultrasonic transducer: polyurethane foam, glass epoxy resin)
Weight	30 g
Thread size	M18 x 1
Connection type	Male connector, M12, 5-pin

Ambient data

Ambient temperature, operation	-25 °C ... +70 °C
Ambient temperature, storage	-40 °C ... +85 °C

Certificates

EU declaration of conformity	✓
UK declaration of conformity	✓
ACMA declaration of conformity	✓
Moroccan declaration of conformity	✓
China-RoHS	✓
cULus certificate	✓

Classifications

ECLASS 5.0	27270804
ECLASS 5.1.4	27270804
ECLASS 6.0	27270804
ECLASS 6.2	27270804
ECLASS 7.0	27270804
ECLASS 8.0	27270804
ECLASS 8.1	27270804
ECLASS 9.0	27270804
ECLASS 10.0	27270804
ECLASS 11.0	27270804
ECLASS 12.0	27272806
ETIM 5.0	EC001846

ETIM 6.0	EC001846
ETIM 7.0	EC001846
ETIM 8.0	EC001846
UNSPSC 16.0901	41111960

Dimensional drawing UM18-2xxxxx2

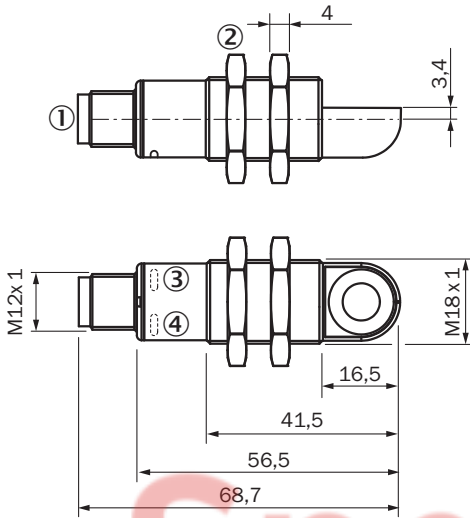

Dimensions in mm (inch)

- ① Connection
- ② Fixing nuts, width 24 mm
- ③ Status display for supply voltage active (green)
- ④ Status indicator switching/analog output (orange)

Connection type

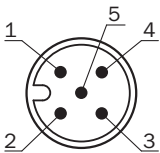

Connection diagram UM18-21xxx6xxx UM18-21xxx7xxx Connector M12, 5-pin

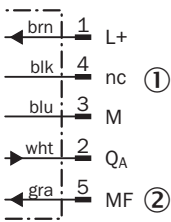

- ① Not assigned
- ② multifunctional input/synchronization and multiplex operation/communication Connect+

Detection area UM1x-x17









- ① Detection range dependent on reflection properties, size, and alignment of the object
- ② Limiting range
- ③ operating range
- ④ example object: aligned plate 500 mm x 500 mm
- ⑤ Example object: cylindrical bar with a diameter of 10 mm



Recommended accessories

Other models and accessories → www.sick.com/UM18

	Brief description	Type	part no.
programming devices			
	<ul style="list-style-type: none"> • Product segment: Integration modules and adapters • Product family: Cloning modules • Description: Tool for visualization, configuration and cloning, 3-digit LED display, supply voltage: DV 9 V ... 30 V 	Connect+ adapter (CPA)	6037782
Mounting systems			
	<ul style="list-style-type: none"> • Description: Mounting plate for M18 sensors • Material: Steel • Details: Steel, zinc coated • Items supplied: Without mounting hardware • Suitable for: GR18, V180-2, V18, W15, Z1, Z2 	BEF-WG-M18	5321870
reflectors and optics			
		USP-UM18	5323658

	Brief description	Type	part no.
connectors and cables			
	<ul style="list-style-type: none"> • Connection type head A: Female connector, M12, 5-pin, straight, A-coded • Connection type head B: Flying leads • Signal type: Sensor/actuator cable • Cable: 2 m, 5-wire, PVC • Description: Sensor/actuator cable, unshielded • Application: Zones with chemicals, Uncontaminated zones 	YF2A15-020VB5XLEAX	2096239
	<ul style="list-style-type: none"> • Connection type head A: Female connector, M12, 5-pin, straight, A-coded • Connection type head B: Flying leads • Signal type: Sensor/actuator cable • Cable: 0.6 m, 5-wire, PVC • Description: Sensor/actuator cable, unshielded • Application: Zones with chemicals, Uncontaminated zones 	YF2A15-C60VB5XLEAX	2145570
	<ul style="list-style-type: none"> • Connection type head A: Female connector, M12, 5-pin, straight, A-coded • Connection type head B: Flying leads • Signal type: Sensor/actuator cable • Cable: 3 m, 5-wire, PVC • Description: Sensor/actuator cable, unshielded • Application: Zones with chemicals, Uncontaminated zones 	YF2A15-030VB5XLEAX	2145572



SICK AT A GLANCE

SICK is one of the leading manufacturers of intelligent sensors and sensor solutions for industrial applications. A unique range of products and services creates the perfect basis for controlling processes securely and efficiently, protecting individuals from accidents and preventing damage to the environment.

We have extensive experience in a wide range of industries and understand their processes and requirements. With intelligent sensors, we can deliver exactly what our customers need. In application centers in Europe, Asia and North America, system solutions are tested and optimized in accordance with customer specifications. All this makes us a reliable supplier and development partner.

Comprehensive services complete our offering: SICK LifeTime Services provide support throughout the machine life cycle and ensure safety and productivity.

For us, that is “Sensor Intelligence.”

WORLDWIDE PRESENCE:

Contacts and other locations – www.sick.com

SpareCruX