



WTT190L-A2232

WTT190 PowerProx

TIME-OF-FLIGHT SENSORS

SICK
Sensor Intelligence.



Illustration may differ



Ordering information

Type	part no.
WTT190L-A2232	6062144

Included in delivery: BEF-W190 (1)

Other models and accessories → www.sick.com/WTT190_PowerProx

Detailed technical data

Features

Functional principle	Photoelectric proximity sensor
Functional principle detail	Background suppression, Optical time-of-flight
Housing design (light emission)	Rectangular
Sensing range max.	200 mm ... 3,000 mm ¹⁾
Sensing range	200 mm ... 3,000 mm ²⁾
Distance value	
Measuring range	200 mm ... 3,000 mm ¹⁾
Resolution	2,000 µm
Repeatability	5 mm ... 80 mm ^{3) 4) 5)}
Accuracy	Typ. ± 30 mm, typ. ± 50 mm ^{6) 7)}
Type of light	Visible red light
Light source	Laser ⁸⁾
Light spot size (distance)	Ø 12 mm (3,000 mm)
Wave length	658 nm
Laser class	1 (IEC 60825-1 / CDRH 21 CFR 1040.10 & 1040.11)

¹⁾ Object with 6 ... 90% remission (based on standard white, DIN 5033).

²⁾ Adjustable.

³⁾ Equivalent to 1 σ .

⁴⁾ See characteristic curves repeatability.

⁵⁾ 6% ... 90% remission factor.

⁶⁾ 0.2 m ... 2 m.

⁷⁾ 2 m ... 3 m.

⁸⁾ Average service life: 100,000 h at $T_U = +25 \text{ }^\circ\text{C}$.

Adjustment	Single teach-in button (4 x), Display
Items supplied	BEF-W190 mounting bracket
Safety-related parameters	
	MTTF _D 170 years
	DC _{avg} 0 %

1) Object with 6 ... 90% remission (based on standard white, DIN 5033).

2) Adjustable.

3) Equivalent to 1 σ .

4) See characteristic curves repeatability.

5) 6% ... 90% remission factor.

6) 0.2 m ... 2 m.

7) 2 m ... 3 m.

8) Average service life: 100,000 h at T_U = +25 °C.

Electronics

Supply voltage U_B	12 V DC ... 30 V DC ¹⁾
Ripple	< 5 V _{pp} ²⁾
Current consumption	75 mA ³⁾
Switching output	PNP ⁴⁾ NPN ⁵⁾
Number of switching outputs	1 (Q ₁) ⁴⁾
Switching mode	Light/dark switching ⁴⁾
Switching mode selector	Selectable via menu
Output current I_{max}	≤ 100 mA
Response time	0.6 ms ⁶⁾ 1 ms ⁷⁾ 3.4 ms ⁸⁾ 13 ms 51.4 ms
Switching frequency	833 Hz, 500 Hz, 147 Hz, 38 Hz, 10 Hz ^{7) 8) 9)}
Time functions	Without time delay Off delay Switch-on delay One shot
Delay time	Programmable, 0 ms ... 999 ms
Analog output	4 mA ... 20 mA (≤ 300 Ω) / 0 V ... 10 V (≥ 10 kΩ) / switchable

1) Limit values. Operated in short-circuit protected network: max. 8 A.

2) May not fall below or exceed U_y tolerances.

3) Without load. At V_S = 24 V.

4) Q₁ = 1 switching threshold, light/dark switching selectable via light/dark selector.

5) PNP/NPN switchable.

6) Signal transit time with resistive load.

7) Can be set via a mean value filter (AVG1, AVG4, AVG16, AVG64, AVG256).

8) Depending on distance to object, distance to background and selected switching threshold.

9) With light/dark ratio 1:1.

10) A = V_S connections reverse-polarity protected.

11) B = inputs and output reverse-polarity protected.

12) C = interference suppression.

13) For optimum performance observe max. warm-up time of 5 minutes.

Resolution of analog output	10 bit
Output time	≤ 0.6 ms ⁷⁾
Input	MF _{in} = multifunctional input programmable
Circuit protection	A ¹⁰⁾ B ¹¹⁾ C ¹²⁾
Protection class	III
Enclosure rating	IP67
Warm-up time	< 5 min ¹³⁾
Initialization time	< 300 ms

¹⁾ Limit values. Operated in short-circuit protected network: max. 8 A.

²⁾ May not fall below or exceed U_v tolerances.

³⁾ Without load. At V_S = 24 V.

⁴⁾ Q1 = 1 switching threshold, light/dark switching selectable via light/dark selector.

⁵⁾ PNP/NPN switchable.

⁶⁾ Signal transit time with resistive load.

⁷⁾ Can be set via a mean value filter (AVG1, AVG4, AVG16, AVG64, AVG256).

⁸⁾ Depending on distance to object, distance to background and selected switching threshold.

⁹⁾ With light/dark ratio 1:1.

¹⁰⁾ A = V_S connections reverse-polarity protected.

¹¹⁾ B = inputs and output reverse-polarity protected.

¹²⁾ C = interference suppression.

¹³⁾ For optimum performance observe max. warm-up time of 5 minutes.

Mechanics

Dimensions (W x H x D)	17.4 mm x 45.6 mm x 34.7 mm
Housing material	Plastic, ABS
Optics material	Plastic, PMMA
Weight	25 g
Connection type	Male connector M8, 4-pin

Ambient data

Ambient operating temperature	-30 °C ... +50 °C ¹⁾
Ambient temperature, storage	-40 °C ... +70 °C

¹⁾ U_v ≥ 24 V. At Tu < -10 °C warm-up time < 10 min.

Classifications

ECLASS 5.0	27270904
ECLASS 5.1.4	27270904
ECLASS 6.0	27270904
ECLASS 6.2	27270904
ECLASS 7.0	27270904
ECLASS 8.0	27270904
ECLASS 8.1	27270904
ECLASS 9.0	27270904
ECLASS 10.0	27270904
ECLASS 11.0	27270904

ECLASS 12.0	27270903
ETIM 5.0	EC002719
ETIM 6.0	EC002719
ETIM 7.0	EC002719
ETIM 8.0	EC002719
UNSPSC 16.0901	39121528

Certificates

EU declaration of conformity	✓
UK declaration of conformity	✓
ACMA declaration of conformity	✓
Moroccan declaration of conformity	✓
China RoHS	✓
cRUus certificate	✓
Laser safety (IEC 60825-1) certificate	✓

Dimensional drawing

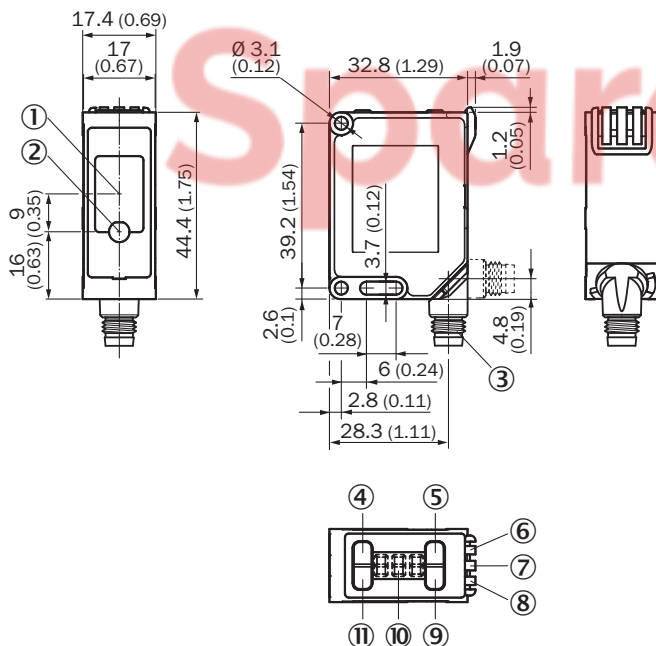

Dimensions in mm (inch)

- ① receiver
- ② sender
- ③ Connection
- ④ RUN button
- ⑤ (+) button
- ⑥ Status indicator orange: output indicator
- ⑦ Status indicator LED, green/red/off: power on / stability indicator / laser off
- ⑧ Status indicator orange: output indicator
- ⑨ (-/Q1) button
- ⑩ Display
- ⑪ SET button

Connection diagram Cd-372

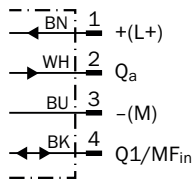

Characteristic curve

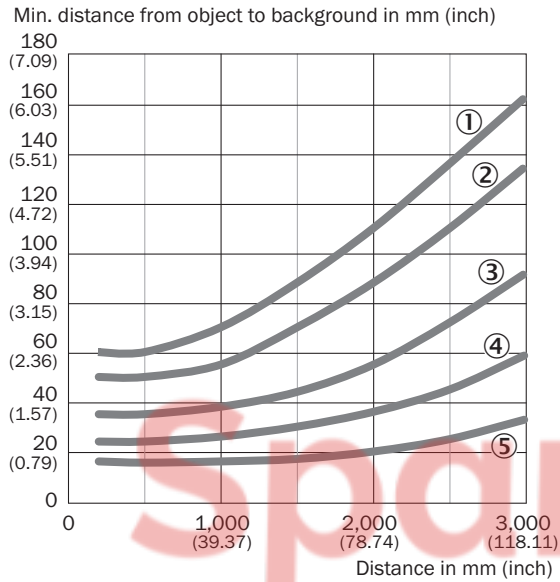

- ① 90 % / 90 % AVG1
- ② 90 % / 90 % AVG4
- ③ 90 % / 90 % AVG16
- ④ 90 % / 90 % AVG64
- ⑤ 90 % / 90 % AVG256

Characteristic curve

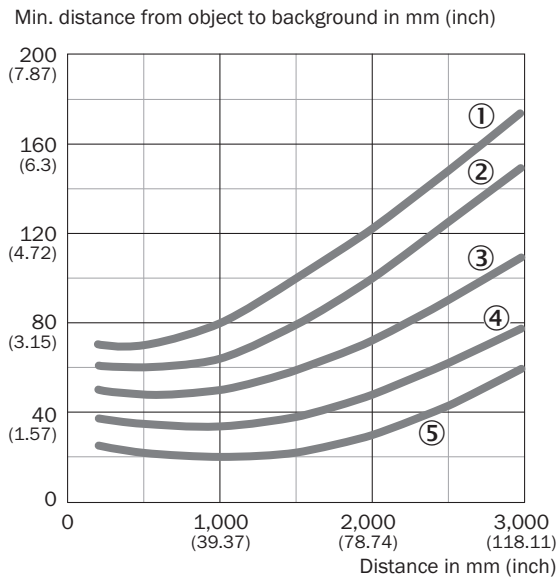

- ① 6% / 90% AVG1
- ② 6% / 90% AVG4
- ③ 6% / 90% AVG16
- ④ 6% / 90% AVG64
- ⑤ 6% / 90% AVG256



Characteristic curve

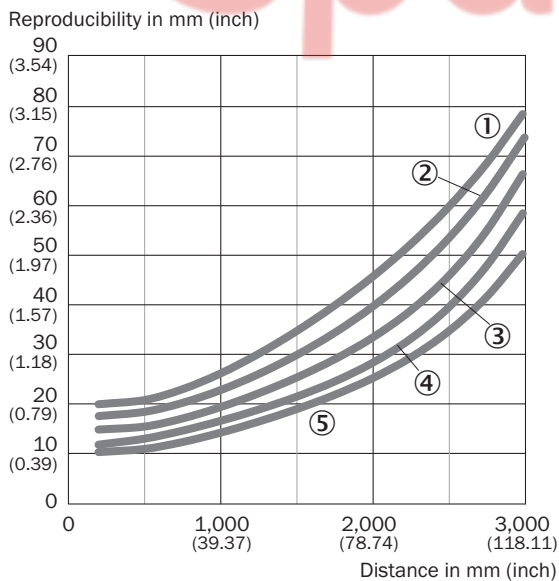

- ① 6% AVG1
- ② 6% AVG4
- ③ 6% AVG16
- ④ 6% AVG64
- ⑤ 6% AVG256

Characteristic curve

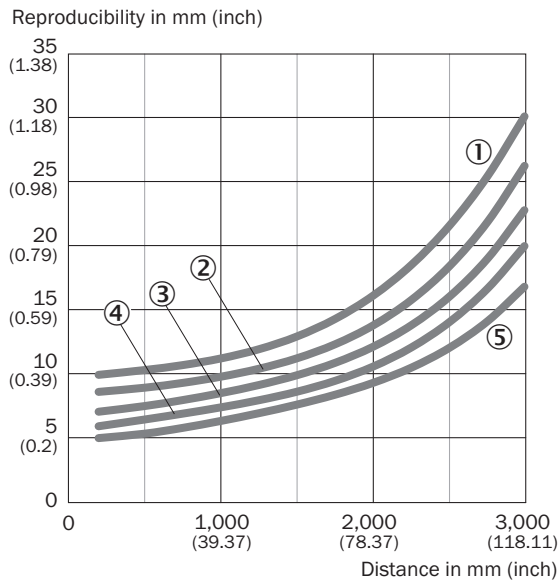

- ① 90 % AVG1
- ② 90 % AVG4
- ③ 90 % AVG16
- ④ 90 % AVG64
- ⑤ 90 % AVG256



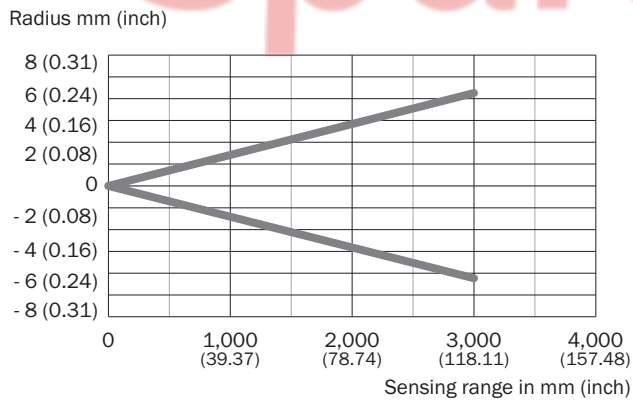

Light spot size



Recommended accessories

Other models and accessories → www.sick.com/WTT190_PowerProx

	Brief description	Type	part no.
connectors and cables			
	<ul style="list-style-type: none"> • Connection type head A: Female connector, M8, 4-pin, straight, A-coded • Connection type head B: Flying leads • Signal type: Sensor/actuator cable • Cable: 5 m, 4-wire, PVC • Description: Sensor/actuator cable, unshielded • Application: Zones with chemicals, Uncontaminated zones 	YF8U14-050VA3XLEAX	2095889
	<ul style="list-style-type: none"> • Connection type head A: Male connector, M8, 4-pin, straight, A-coded • Description: Unshielded • Connection systems: Screw-type terminals • Permitted cross-section: 0.14 mm² ... 0.5 mm² 	STE-0804-G	6037323

SpareCruX

SICK AT A GLANCE

SICK is one of the leading manufacturers of intelligent sensors and sensor solutions for industrial applications. A unique range of products and services creates the perfect basis for controlling processes securely and efficiently, protecting individuals from accidents and preventing damage to the environment.

We have extensive experience in a wide range of industries and understand their processes and requirements. With intelligent sensors, we can deliver exactly what our customers need. In application centers in Europe, Asia and North America, system solutions are tested and optimized in accordance with customer specifications. All this makes us a reliable supplier and development partner.

Comprehensive services complete our offering: SICK LifeTime Services provide support throughout the machine life cycle and ensure safety and productivity.

For us, that is “Sensor Intelligence.”

WORLDWIDE PRESENCE:

Contacts and other locations – www.sick.com

SpareCruX